

Research Progress and Accomplishments

1997-1999

*A
Selection of
Papers
Chronicling
Technical
Achievements
of the
Multidisciplinary
Center for
Earthquake
Engineering
Research*

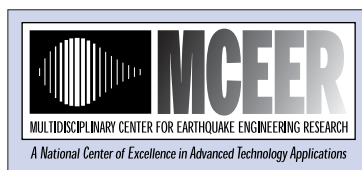

▲ *The Multidisciplinary Center for Earthquake Engineering Research*

The Multidisciplinary Center for Earthquake Engineering Research (MCEER) is a national center of excellence in advanced technology applications that is dedicated to the reduction of earthquake losses nationwide. Headquartered at the University at Buffalo, State University of New York, the Center was originally established by the National Science Foundation (NSF) in 1986, as the National Center for Earthquake Engineering Research (NCEER).

Comprising a consortium of researchers from numerous disciplines and institutions throughout the United States, the Center's mission is to reduce earthquake losses through research and the application of advanced technologies that improve engineering, pre-earthquake planning and post-earthquake recovery strategies. Toward this end, the Center coordinates a nationwide program of multidisciplinary team research, education and outreach activities.

Funded principally by NSF, the State of New York and the Federal Highway Administration (FHWA), the Center derives additional support from the Federal Emergency Management Agency (FEMA), other state governments, academic institutions, foreign governments and private industry.

Research Progress and Accomplishments

1997-1999

Multidisciplinary Center for Earthquake Engineering Research
University at Buffalo, State University of New York

July 1999

Red Jacket Quadrangle, Buffalo, New York 14261
Tel: (716) 645-3391; Fax: (716) 645-3399; Email: mceer@acsu.buffalo.edu
World Wide Web: <http://mceer.buffalo.edu>

Foreword

*by George C. Lee, Director,
Multidisciplinary Center for Earthquake Engineering Research*

The research accomplishments of the Multidisciplinary Center for Earthquake Engineering Research are as numerous as they are varied. Since the Center was established by the National Science Foundation (NSF) in 1986, its vision has been to help establish earthquake resilient communities throughout the United States and abroad. Over the past 13 years, our research and education programs have annually supported more than 80 investigators throughout the country and the world, to work toward this goal. Much has been accomplished, most notably in the areas of lifelines and protective systems, but our vision has not yet been fully realized.

Toward this end, we believe that the best way to achieve earthquake resilient communities in the short-term is to invest in two highly-focused system-integrated endeavors:

- the rehabilitation of critical infrastructure facilities such as hospitals and lifelines that society will need and expect to be operational following an earthquake; and
- the improvement of emergency response and crisis management capabilities to ensure efficient response and prompt recovery following earthquakes.

Our research is conducted under the sponsorship of two major federal agencies, the NSF and the Federal Highway Administration (FHWA), and the state of New York. Significant support is also derived from the Federal Emergency Management Agency (FEMA), other state governments, academic institutions, foreign governments and private industry. Together these resources are used to implement our research programs, as shown below.

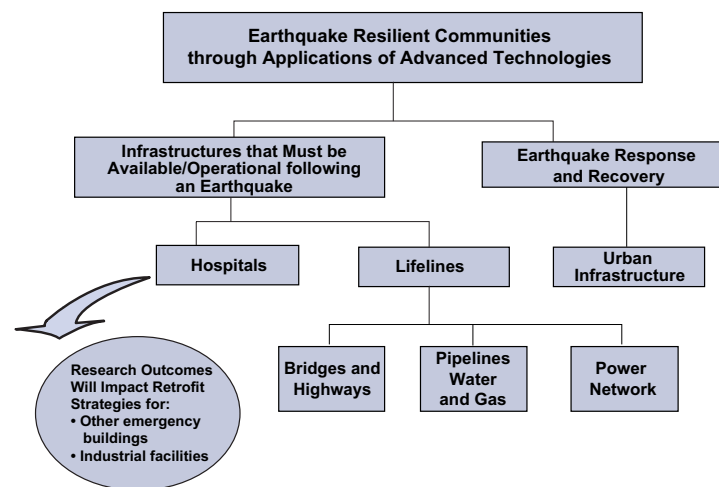

This *Research Progress and Accomplishments* report is intended to introduce the reader to and highlight some of MCEER's research tasks that are currently in progress, and provide those in the earthquake engineering community with a glimpse of the foci and direction that our programs are taking. We anticipate that this information will contribute to the coordination and collaboration effort

in earthquake engineering research nationally and globally. The presentation is in descriptive form with preliminary observations and recommendations, and provides an indication of future efforts.

The research studies represented in this report are in various stages of completion. A few papers describe efforts that have been completed and are now represented in codes, standards, and regional or national guidelines. Others describe work in progress.

Each paper, whether it be on developing loss estimation techniques, construction of a benchmark model for repetitive testing, or the vulnerability analysis of the Los Angeles Department of Water and Power's vast network, provides a snapshot of how MCEER accomplishes its multidisciplinary and team-oriented research. The authors identify the sponsors of the research, collaborative partners, related research tasks within MCEER's various programs, and links to research and implementation efforts outside MCEER's program.

MCEER works with all members of the earthquake engineering community, including practicing engineers and other design professionals, policymakers, regulators and code officials, facility and building owners, governmental entities, and other stakeholders who have responsibility for loss reduction decision making. The end users of the presented research are also highlighted within each paper, which we hope will enhance MCEER's partnership programs with industry, government agencies and others.

This report is the first in what we anticipate will be an annual compilation of research progress and accomplishments. Future issues will include a brief overview of our strategic research plan to further enhance cooperative research efforts. The report is available in both printed and electronic form (on our web site in PDF format at <http://mceerbuffalo.edu>)

If you would like more information on any of the studies presented herein, or on other MCEER research or educational activities, you are encouraged to contact us by telephone at (716) 645-3391, facsimile (716) 645-3399, or email at mceer@acsu.buffalo.edu.

Contents

A New Application for Remotely Sensed Data: Construction of Building Inventories Using Synthetic Aperture Radar Technology	1
<i>Ronald T. Eguchi, EQE International, Inc.; Bijan Houshmand, MCEER Consultant; Charles K. Huyck, EQE International, Inc.; Masanobu Shinozuka, University of Southern California; and David M. Tralli, MCEER Consultant</i>	
Improving Earthquake Loss Estimation: Review, Assessment and Extension of Loss Estimation Methodologies	13
<i>Kathleen J. Tierney, University of Delaware; Stephanie E. Chang and Ronald T. Eguchi, EQE International, Inc.; Adam Rose, Pennsylvania State University; and Masanobu Shinozuka, University of Southern California</i>	
Benchmark Models for Experimental Calibration of Seismic Fragility of Buildings	29
<i>Andrei M. Reinhorn, Michael C. Constantinou and Dyab Kusumastuti, University at Buffalo, State University of New York</i>	
Development of a Semi-Active Structural Control System	35
<i>George C. Lee, Zhong Liang and Mai Tong, University at Buffalo, State University of New York</i>	
GIS Characterization of the Los Angeles Water Supply, Earthquake Effects and Pipeline Damage	45
<i>Thomas D. O'Rourke, Selcuk Toprak and Sang-Soo Jeon, Cornell University</i>	
Axial Behavior Characteristics of Pipe Joints Under Static Loading	55
<i>Emmanuel Maragakis, Raj Siddharthan and Ronald Meis, University of Nevada, Reno</i>	
Seismic Performance Analysis of Electric Power Systems	61
<i>Masanobu Shinozuka and Tsen-Chung Cheng, University of Southern California; Maria Q. Feng, University of California, Irvine; and Sheng-Taur Mau, New Jersey Institute of Technology</i>	
National Representation of Seismic Hazard and Ground Motion for Highway Facilities	71
<i>Maurice Power and Shyh-Jeng Chiou, Geomatrix Consultants, Inc. and Ronald L. Mayes, Dynamic Isolation Systems, Inc., for the Applied Technology Council</i>	
Updating Assessment Procedures and Developing a Screening Guide for Liquefaction	81
<i>T. Leslie Youd, Brigham Young University</i>	

Fragility Curve Development for Assessing the Seismic Vulnerability of Highway Bridges	91
<i>John B. Mander, University at Buffalo, State University of New York</i>	
Changes in the New AASHTO Guide Specifications for Seismic Isolation Design	101
<i>Michael C. Constantinou, University at Buffalo, State University of New York</i>	
Seismic Retrofitting Manuals for Highway Systems	111
<i>Ian M. Friedland, Multidisciplinary Center for Earthquake Engineering Research and Ian G. Buckle, University of Auckland</i>	

A New Application for Remotely Sensed Data: Construction of Building Inventories Using Synthetic Aperture Radar Technology

by Ronald T. Eguchi, EQE International, Inc.; Bijan Houshmand, MCEER Consultant; Charles K. Huyck, EQE International, Inc.; Masanobu Shinozuka, University of Southern California; and David M. Tralli, MCEER Consultant

Research Objectives

The MCEER research team is attempting to use Synthetic Aperture Radar (SAR) technology in combination with digital elevation models (DEM) to create building inventories for highly urbanized areas. If successful, these techniques could revolutionize the way in which structural inventory data are compiled for large cities. One particular application that is especially relevant to the MCEER program is the development of building inventory data for loss estimation modeling. Current methods of inventory development are often expensive to apply, can result in incomplete datasets, and are generally not standardized. Because of these shortcomings, these methods are employed only periodically, thus rendering the data static during its application.

We intend to explore the use of airborne SAR data, along with other remotely sensed data, to construct building inventories for loss estimation modeling. In our study, we have two specific research objectives:

1. Using a combination of remote sensing technologies, discriminate with a high degree of confidence the difference between the built and natural environment.
2. With a moderate level of reliability, quantify the important structural and economic parameters associated with large-scale urban and suburban developments (building heights, floor areas, replacement values, material or structural types, and usage).

This research program focuses on methodology development, data analysis and fusion, and application to the Los Angeles area. The ultimate goal of the research is to improve loss estimation modeling by creating more accurate building inventories. A related program area – damage detection modeling – is discussed in another paper (see *Improving Earthquake Loss Estimation: Review, Assessment and Extension of Loss Estimation Methodologies*).

Images, measurements and other data obtained from the vantage point of high altitude aircraft and satellites have recently entered the technology arsenal of disaster specialists. Technologies such as synthetic aperture radar (or more commonly known as SAR) have been instrumental in measuring the movement of the earth's crust due to large- and medium-sized earthquakes. Minute displacements on the order of several centimeters

Sponsors

MCEER/NSF

Collaborative Partners

Mike Bullock, Intermap Technologies Ltd.

Stephanie E. Chang, EQE International, Inc.

Masashi Matsuoka, Earthquake Disaster Mitigation Research Center, Japan

Bryan Mercer, Intermap Technologies Ltd.

Ken Rath, Intermap Technologies Ltd.

Kathleen J. Tierney, Disaster Research Center, University of Delaware

Marc Wride, Intermap Technologies Ltd.

Fumio Yamazaki, Earthquake Disaster Mitigation Research Center, Japan

Related MCEER Research Activities

- *Loss Estimation Methodologies*, **K.J. Tierney**, University of Delaware, **S. Chang**, EQE International, **A. Rose**, Pennsylvania State University and **M. Shinozuka**, University of Southern California

have been measured by comparing radar data taken before and after the event. By measuring the difference in return times of the radar signal to and from the target for paired images, scientists can detect whether the ground has moved either closer or further away from the sensor, i.e., satellite. This technique of radar interferometry has been successfully applied in measuring the large-scale regional movement of the Los Angeles basin during the 1992 Landers earthquake (Massonnet et al., 1993) and the 1995 Kobe earthquake (Ozawa et al., 1997).

This capability to measure elevation changes can serve other useful purposes. SAR technology has demonstrated significant value in creating digital elevation models (DEM) for non-urban areas. Using airborne SAR technology with dual sensors, it is possible to create accurate DEMs inexpensively and on a regular basis. Presently, this is the most popular application of airborne SAR technology.

Technical Summary

Figures 1 and 2 show two images of the same geographical area. Visible in both images is the downtown Los Angeles area with its freeways, streets and open areas. Figure 1 represents a SAR (intensity) image

created from data produced by an airborne SAR system operated by Intermap Technologies; Figure 2 is a geographic information system (GIS) map layer of taxable properties for the same area. A quick review of both images suggests similar regional characteristics, even though each image was developed from an entirely different data source. The top image was created using an automated SAR processing algorithm. Data collected from a single flight over Los Angeles (May 1998) was processed in a matter of hours, resulting in digital elevation models and reflectance or intensity data. Intensities vary throughout the imaged region depending upon look angle from the sensor, the type of material being imaged, and other factors, which may vary from day to day (e.g., moisture content and condition of vegetation or foliage). The bottom image (Figure 2) was created over a period of several months. Data from the Los Angeles County Tax Assessor's Office were used in identifying building locations, types, sizes, heights and uses. Unfortunately, only data on taxable properties were available leaving many government buildings and facilities out of the compilation. This lack of information results in what appears to be open areas or zones in Figure 2. Furthermore, freeways and other infrastructure systems, which

Building inventories are essential for all loss estimation models. Although differences may exist in exactly how to characterize building types, all loss estimation models require an estimate of number of buildings or total square footage. Users of building inventory methodologies include loss estimation modelers, government agencies, and various private-sector groups, including insurance companies, real estate organizations, and financial institutions.

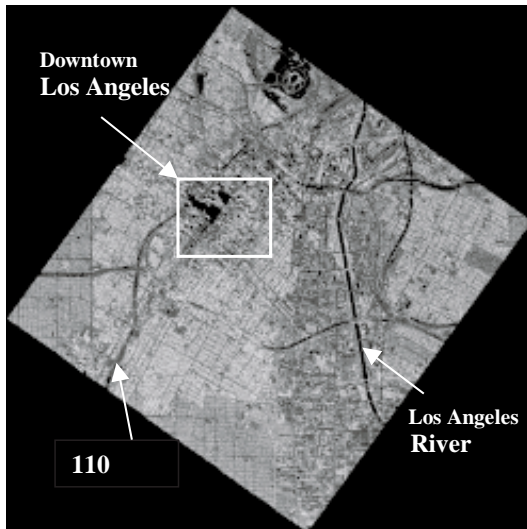

Data Source: Intermap Technologies, May 1998

■ **Figure 1.** SAR Intensity Image of Downtown Los Angeles

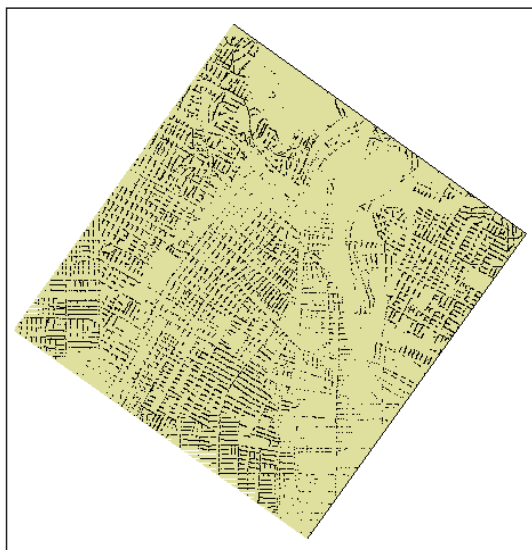

Data Source: LA Co. Tax Assessor's Office, 1994

■ **Figure 2.** GIS Map Layer of Building Locations

appear in the SAR image, do not appear in Figure 2.

At the present time, most detailed loss estimation models use data from tax assessor files to create building inventories. Although recognized as not being complete, they often represent the best available data to develop information on number of buildings, building size,

age, type, usage, and story height. As mentioned earlier, the most significant drawback is the expensive nature of the data. In the example (see Figure 2), roughly four person-months were required to collect, process and validate data on 1.7 million structures in Los Angeles County.

Understanding the nature of the built environment will also be key in developing rapid post-earthquake damage assessment tools. Without accurate knowledge of what is exposed during a large event, it may be impossible to measure the full extent of the disaster. In a separate section of this report, we discuss how remotely sensed data can be used to quickly identify areas of severe damage. Using interferometric techniques, we are confident that significant damage (e.g., burnt areas, collapsed houses, and fallen bridges) can be identified by comparing pre- and post-event imagery.

The paper begins with an introduction to some basic radar imagery principles. For most readers, the idea of radar should not be new, however, its application to disaster management may be. For this reason, we define basic terms and attempt to describe their usage within the context of urban applications. The importance of describing the surface of the earth in terms of roughness, vegetation cover, height profile, and level of development will be key in understanding how to separate the built from the

“Without accurate knowledge of what is exposed during a large earthquake, it may be impossible to measure the full extent of the disaster.”

For more details on SAR and IFSAR, see NASA's Jet Propulsion Laboratory's imaging radar home page at <http://southport.jpl.nasa.gov> or the Environmental Research Institute of Michigan at <http://erim.org>.

natural environment. Next, we describe important considerations in relating SAR information to building inventory data. As the reader will see, characterizing buildings by their footprint and height are the initial steps in developing usable data for building inventories.

Although we are in the midst of our research program, we do validate in this paper several important modeling assumptions. In particular, we show that by using remotely sensed data and a multi-spectral classification scheme, we can in fact identify the footprints of small and large buildings. We also demonstrate that it is possible to quantify the heights of buildings by using DEM data from airborne SAR surveys. Both of these validations are extremely important in constructing an automated scheme for building inventory development. Finally, we provide a glimpse of future research tasks. Ultimately, we intend to describe the composition of urban areas by a set of SAR "signatures." These signatures will distinguish between different development types (residential, commercial, industrial and mixed), various levels of density and possibly different building materials.

Basic Principles about Radar, SAR and IFSAR

Radar imaging works by sending microwave pulses toward a target and measuring the return time and intensity that is reflected back to the sensor or antenna. Normally, wavelengths are on the order of 1 cm to 1 m, which corresponds to a frequency range of about 30 GHz to 300 MHz. For an imaging radar system, about 1500 high-power pulses per second are transmitted

toward the target, with each pulse having a duration of about 10-50 microseconds. Typical bandwidths fall in the range of 10 to 200 MHz. Higher bandwidths correspond to finer resolutions of the image.

The term synthetic aperture radar, or SAR, refers to the technique used to simulate a long antenna by combining signals (echos) received by the sensor as it moves along a particular flight track. In the case of SAR, both phase and amplitude information are used, in contrast to conventional radar that uses only amplitude. This allows a larger aperture to be synthesized, thus allowing for higher resolution images. SAR imaging is possible using both airborne (jet) and spaceborne (satellite) platforms. For example, in the U.S., airborne systems are operated by the National Aeronautics and Space Administration (NASA) with its Air-SAR system, and by Intermap Technologies, through its Star-3 system. Satellite-based systems that offer SAR capabilities include Radarsat, ERS-1 and ERS-2, and J-ERS. These systems should be distinguished from those that primarily offer optical imaging, e.g., SPOT and Landsat.

The products from SAR imaging fall into three basic categories: elevation data, reflectance or intensity data, and correlation information. Elevation information is possible when IFSAR data are collected. IFSAR refers to interferometric synthetic aperture radar and is usually performed using an airborne or spaceborne platform with dual antennae. A SAR image is formed for each receiving antenna with each image having an associated magnitude and phase. The difference in return times from the two antennae appear as a difference in phase for each pixel imaged. These differences will vary from pixel to pixel and this

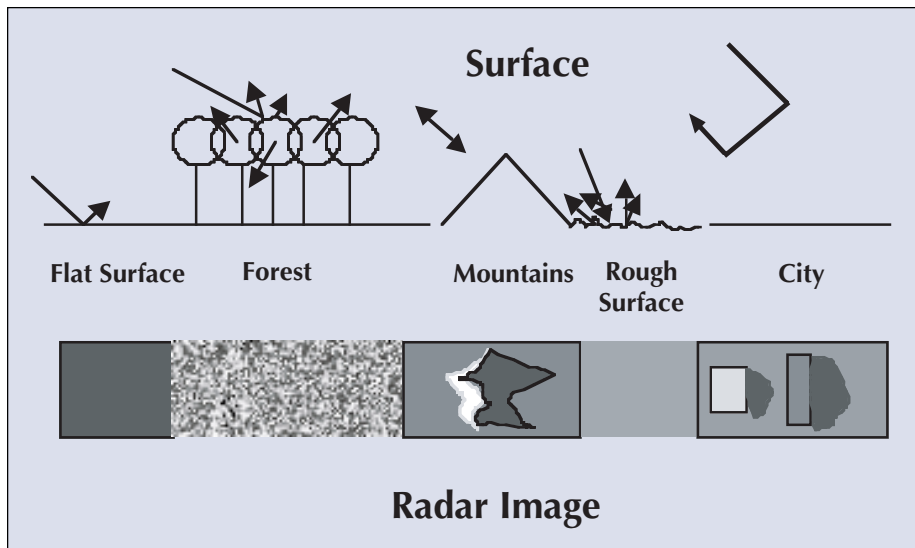

■ Figure 3. Radar Image versus Ground Surface

information eventually characterizes the height differences on the ground. See <http://southport.jpl.nasa.gov> or <http://erim.org> for more details on SAR and IFSAR. The reader is also referred to Rodriguez and Martin (1992) and Gabriel and Goldstein (1988) for more information on interferometry.

When a radar image is viewed, what is seen is a mosaic of dots of varying shades and intensities. Each pixel represents a radar backscatter for that area on the ground. Depending upon the roughness of the surface, the moisture level of that area, or the “look” angle from the sensor, the processed image may be light or dark. Light or bright areas represent high backscatter, or areas which return a large fraction of the radar energy back to the sensor; dark areas represent low backscatter, or areas which tend to reflect much of the energy away from the sensor. Flat areas typically result in low backscatter, while areas containing extensive vegetation tend to be high backscatterers. Depending upon the orientation of buildings and streets relative to the sensor, backscattering may be high or low.

Figure 3 provides an illustration of radar images based on different surface conditions.

Another important concept in understanding the properties of the earth’s surface is multi- and hyperspectral analysis. It is possible using a variety of different sensors (SPOT High-Resolution Visible multi-spectral data, SPOT panchromatic imagery, Landsat-TM, and U.S. Geological Survey aerial photographs) to classify the land cover of an area. Each sensor offers a range of visible and in some cases, infrared bands that characterize the chemical composition of the earth’s materials and vegetation (Goetz et al., 1985; Smith et al., 1990). Taxonomy schemes that have been verified through field surveys often allow classification of vegetation by type using the above data. These same procedures are useful in separating buildings from surrounding vegetation.

In the next subsection, we will discuss how remotely sensed data can be used to: 1) separate buildings from the natural environment and 2) quantify the heights of buildings. We will demonstrate these concepts using data collected for the Los Angeles area.

Key Considerations in Relating SAR Parameters to Building Inventory Information

There are two important considerations in translating SAR data into building inventory information: 1) outlining building footprints and 2) characterizing building heights. With these two parameters, it is possible to construct enough information to quantify total square footage and possibly building construction type. With total square footage, one can estimate the replacement cost of a building, thus providing a key piece of information in characterizing exposure. By knowing the height of a building, one might infer a particular building material type (e.g., steel, concrete, wood, etc.) or construction system for some specific region or area.

Table 1 shows the distribution of buildings in Los Angeles County by story height and material type. The data source for this information was the Los Angeles County Tax Assessor's Office; therefore, non-taxable properties such as government buildings are not included in this summary. The table shows that the most predominant construction

type is wood-frame construction, accounting for all but 0.05 percent of the total. However, for story heights greater than four stories, the inventory is comprised of either steel, concrete or brick/concrete block/other concrete buildings. For buildings in the 4 to 7 story height category, it is more likely that the building type is brick/concrete. For buildings greater than 7 stories, it is likely that the material type would be some kind of steel construction. A more careful analysis by use (residential, commercial, and industrial) may help to refine these distributions further.

Later stages of our research will focus on the classification of construction based on development patterns, building densities, building sizes, roof types and other factors that may characterize building construction practices around the country.

The next two sections discuss how SAR data, along with other remotely sensed information, can be used to define building footprints and heights. Later research reports will summarize how measurement of these two parameters can be translated into information and data required by most loss estimation methodologies.

Building Footprints from Multi-Spectral Imagery Data

In the last several years, there have emerged special imagery tools that allow classification of the earth's materials based on spectral information. These tools can distinguish roads from grassy

■ Table 1. Number of Buildings by Height and Material Type

No. of Stories	Wood-Frame	Steel-Frame	Concrete	Brick, Concrete Block	Total	% Total
0-3	1,677,951	746	896	52,397	1,731,990	99.95
4-7	0	136	127	175	438	0.027
8+	0	190	121	56	367	0.023
Subtotals	1,677,951	1,072	1,144	52,628	1,732,795	100
% Total	96.83	0.06	0.07	3.04	100	100

Source: Los Angeles County Tax Assessor's Office

yards, roofs of buildings from surrounding foliage, and trees and bushes of varying types and sizes. We are beginning to investigate the use of these tools in separating built and natural objects in an urban setting. The data sources for this review include aerial photographs, optical imagery (SPOT), and SAR intensity data. Each of these data sets has major benefits and some drawbacks. In the case of aerial photographs, we are limited to the three visual bands, i.e., red, green and blue. Satellite optical data include some near-infrared bands, however, the present resolution of this data is on the order of 10 to 20 m. The same resolution problem also applies, to some extent, to the SAR data.

It is anticipated, however, that the technology will develop so that high-resolution (1 m) optical and multi-spectral data will be available via satellite in the next few years. Several commercial satellite companies have plans to launch these types of sensors in the year 2000. At that point, the options for defining accurate building footprints will be numerous and less expensive.

Figure 4 shows two images. The first image, Figure 4a, is an aerial photograph of a residential area in the city of Santa Monica, California. The second image, Figure 4b, is a map derived from the aerial data using a classification scheme contained within *ENVI*, an imaging processing software, that distinguishes roof types from other objects, e.g., roads, bushes, trees, etc. It is clear from the comparison that large trees are easily recognized, roadways can be distinguished from yards and improved properties, and that the outlines of buildings are reasonably clear. The significant advantage of Figure 4b is that the information used to derive the image can be translated into vector data that are usable in GIS systems. In fact, the percentage of area covered by building footprints can be quantified relatively easily using GIS technology.

The extraction of building footprints can be complicated by a number of factors. For example, nearby trees often obscure the outline of a building by covering part of the roof. Symmetrically-shaped

“The percentage of area covered by building footprints can be quantified relatively easily using GIS technology”



■ Figure 4. Classification of Building Shapes based on Multi-Spectral Analysis of Aerial Photographs

areas, such as yards or asphalt areas, that often look like the tops of buildings may also complicate the classification of building footprints. Therefore, to outline building footprints using only visual information may not be the most effective approach, particularly if large areas are to be evaluated and checked. However, as a first approximation of footprint area, these data are judged to be adequate.

In addition to aerial photographs, we are investigating the use of SPOT imagery (both panchromatic and multi-spectral) to classify the footprints of buildings. The aerial photographs are useful data in classifying the footprints of short buildings. Since aerial photos are collected at a relatively low elevation, tall buildings which are not directly under the flight path appear to lean in these photos (see Figure 5a). Automatically extracting the footprints of tall buildings using aerial data leads to a horizontal displacement corresponding to the visible portion of the side of the building. Because satellite data are

collected from a higher elevation, displacement of the building footprint due to perspective is very slight. However, the current resolution of the SPOT data is 10 m for the panchromatic images and 20 m for the multi-spectral data. In the future, this may not be a problem with the high-resolution satellite data that will be available.

Building Height Information from SAR Imagery

The concept of measuring the heights of buildings has been demonstrated recently by Houshmand (1996) and Hepner, Houshmand, Kulikov and Bryant (1998) for the Los Angeles area. They were able to show that by using IFSAR and Airborne Visible/Infrared Imaging Spectrometer (AVIRIS) hyper-spectral imagery that it was possible to not only differentiate the complex urban landscape of Los Angeles but also create three-dimensional models of very tall buildings. By using

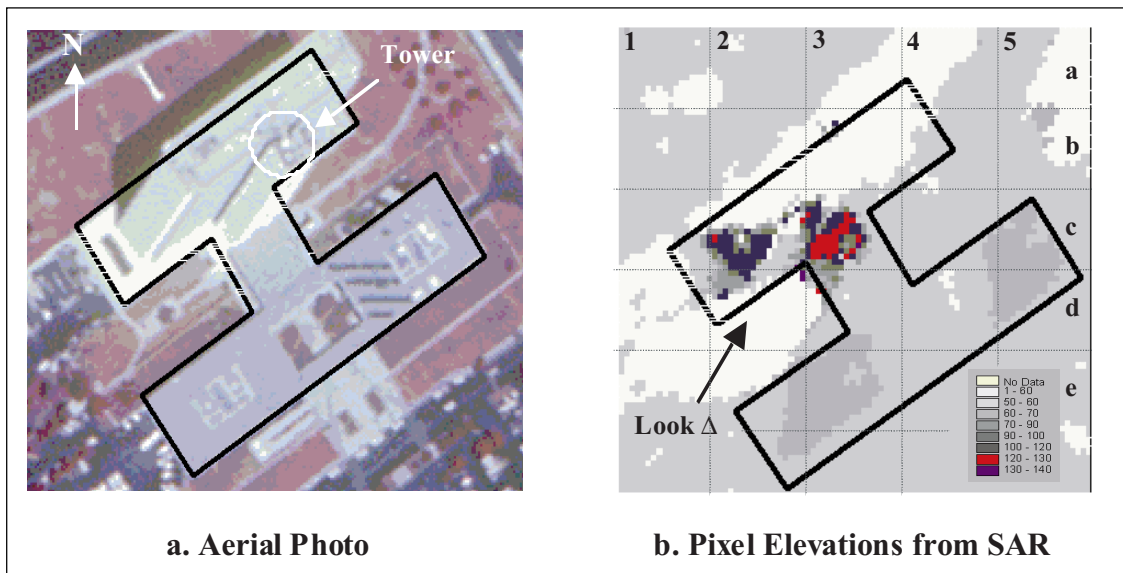

■ Figure 5. Aerial Photo and SAR Elevation Data for Federal Building in West Los Angeles. Note that the Tower in Figure 5a is several meters higher than the rest of the building.

the hyper-spectral imagery to mask surfaces adjacent to tall structures, they were able to determine the baseline topography around buildings and the footprints of tall structures.

Where our study enhances this earlier effort is in addressing all types of development, including densely compacted, low-rise residential construction, and in creating a methodology that can be applied over extremely broad areas, (e.g., large cities). In order to build on this earlier effort, we have applied the techniques described in Hebner et al. (1998) to our demonstration areas. At the present time, we are concentrating on four areas: 1) the Wilshire corridor between Westwood and Santa Monica, 2) the Northridge area which experienced damage after the 1994 earthquake, 3) Downtown Los Angeles, and 4) the University of Southern California campus.

Figure 5 shows an aerial view of the Federal Building located on Wilshire Blvd. near the 405 Freeway. The building is essentially a rectangular-shaped building with a large tower located on the southern boundary. The tower is roughly 10 meters higher than the rest of the building. The overall height of the building (excluding the tower) is over 70 meters. Although the outline in Figure 5 suggests an “H” shape footprint for the building, only the top portion of outline where the tower is located is the actual building. The lower part of the “H” footprint surrounds possibly a parking structure.

In Figure 5b, we observe for the same outline the pixel elevations as determined through analysis of airborne SAR data. The airborne SAR data for this study was provided by

Intermap Technologies Ltd. located in Alberta, Canada and Englewood, Colorado. These data were collected during a flight in late May of 1998 and the general “look” or observation angle is seen in Figure 5b. The posting of data for this flight was 2.5 m. The measurable heights in Figure 5b are seen in quadrants 2c and 3c. In 2c, we are picking up the elevation of the top of the building. In 3c, we are measuring the elevation of the tower. In 3e, and 5c and 5d, we are picking up equipment located on top of the parking structure, which are observable from the aerial photograph in Figure 5a. Note that the elevations shown in the legend have not been normalized to the actual ground height.

What is also evident from this figure is that we are picking up elevation data for only part of the building, i.e., quadrants 2c and 3c. The white areas of the figure indicate parts of the image where no data have been collected. These “no data” areas include quadrants 3a, 3b and 4a. Because of the observation or look angle of the sensor, the tower in quadrant 3c is obstructing our view of these areas. These areas are referred to as “shadow” zones. In addition, there are “no data” zones in quadrants 1d, 1e, 2d and 2e. The reason for this problem is a phenomenon called “layover.” Layover refers to a situation where imaging is often complicated by multiple signals overlaying onto the same pixel. This phenomenon is more of a problem with tall structures. In any event, there are enough elevation observations in Figure 5b to quantify the maximum height of the tower and the building.

We are now in the process of quantifying the heights of smaller buildings, such as dwellings. In these cases, because the footprints are smaller, it is more difficult to pick up reliable heights. This problem is further complicated by the fact that there may be other nearby structures (e.g., trees) that could account for higher elevation data. Preliminary indications are that using this technique of matching building footprint areas with maximum elevation data for residential areas leads to a success rate (i.e., gauging the true story height of residential buildings) of about 60 percent. We are trying to improve this percentage by refining our techniques for extracting height data from SAR images.

In the next section, we present future research plans for validating these techniques for larger urban areas. We hope to complete these validations by the end of this year and then move on to post-earthquake damage assessment techniques.

Future Research Plans

In the next year, we plan to pursue a number of research activities. Most of these will concentrate on refining the methods described above so that they are applicable to a wider range of buildings and development conditions. In all cases, however, the basic modeling assumption remains the same, i.e., we can define the physical dimensions of a building by quantifying its footprint and maximum height. Some of the more notable activities include:

- Validating our modeling assumptions (footprint and height determinations) for a wider range of development types. We currently have four major study areas

which represent varying degrees of development and land usage. We will “ground truth” parts of each study area to validate our classification scheme. Where possible, we will evaluate the efficacy of different datasets in establishing accurate footprint boundaries and building heights.

- Creating a regional index to measure building density and development. Preliminary research using tax assessor’s data indicate that depending upon development type (residential, commercial, industrial or mixed), a small city unit (1/2 mile by 1/2 mile grid cell) will have a unique building height profile or signature. That is, if one were to count up the number of buildings in various height categories and create a cumulative histogram of total number of buildings by story height, one would see vastly different trends for residential, commercial and industrial areas. If these trends could be standardized so that they represent a measure of the total volume of floor space in an area, they could be used as an alternative to existing measures of building inventory.
- Depending on our success in creating these regional building indices, our next step is to test whether it is possible to recognize these “building height signatures” using remote sensed data. If successful, we will have demonstrated an entirely new set of methods for creating building inventories for large regional areas. For loss estimation studies, this would be a major breakthrough since it would then be possible to economically create a building inventory database for any part of the country.

References

- Gabriel, A.K. and Goldstein, R.M., (1988), "Repeat Pass Interferometry," *International Journal of Remote Sensing*, Vol. 9, pp. 857-872.
- Goetz, A.F. et al., (1985), "Imaging Spectrometry for Earth Remote Sensing," *Science*, Vol. 228, pp. 1147-1153.
- Hepner, G.F., Houshmand, B., Kulikov, I. and Bryant, N., (1998), "Investigation of the Integration of AVIRIS and IFSAR for Urban Analysis," *Photogrammetric Engineering & Remote Sensing*, Vol. 64, No. 8, August, pp. 813-820.
- Houshmand, B., (1996), "Urban IFSAR Modeling," *Union of Radio Science Institute Symposium*, Baltimore, Maryland, June.
- Massonnet, D., Rossi, M., Carmona, C., Adragna, F., Peltzer, G., Felgl, K. and Rabaute, T., (1993), "The Displacement Field of the Landers Earthquake Mapped by Radar Interferometry," *Nature*, Vol. 364, July 8.
- Mercer, J.B., (1998), "Radar-Derived DEMs for Urban Areas," *ISPRS Commission IV Symposium*, Stuttgart, September.
- Ozawa, S., Murakami, M., Fujiwara, S. and Tobita, M., (1997), "Synthetic Aperture Radar Interferogram of the 1995 Kobe Earthquake and its Geodetic Inversion," *Geophysical Research Letters*, Vol. 24, No. 18, September, pp. 2327-2330.
- Rodriguez, E. and Martin, J.M., (1992), "Theory and Design of Interferometric Synthetic Aperture Radar," *IEEE Proceedings*, Vol. 139, No. 2, April, pp. 147-159.
- Smith, M.O. et al., (1990), "Vegetation in Deserts: A Regional Measure of Abundance from Multispectral Images," *Remote Sensing of the Environment*, Vol. 31, pp. 1-26.

Improving Earthquake Loss Estimation: Review, Assessment and Extension of Loss Estimation Methodologies

by Kathleen J. Tierney, University of Delaware; Stephanie E. Chang and Ronald T. Eguchi, EQE International; Adam Rose, Pennsylvania State University; and Masanobu Shinozuka, University of Southern California

Research Objectives

The overall goals of the research are to link engineering system vulnerability analysis with the best-available techniques of economic analysis, to produce integrated models of physical and economic loss, and to improve the efficiency and effectiveness of loss estimation methods through the application of advanced and emerging technologies. This program of research focuses both on general methodological refinements and model improvement and on applications that will support MCEER's power and water lifeline and hospital demonstration projects.



MCEER/NSF

Spurred in part by the rising economic costs of natural disasters, there has been a dramatic increase in efforts aimed at estimating the direct and indirect losses caused by earthquakes. For example, in 1997 the journal *Earthquake Spectra* devoted a special issue to loss estimation. Papers appearing in that publication ranged from cost-benefit analyses of structural rehabilitation strategies (D'Ayala et al., 1997) to the development of real-time earthquake damage assessment tools (Eguchi et al., 1997). In 1998, MCEER published a monograph addressing the physical and socio-economic impacts of earthquake-induced electrical power disruption in the central U.S. (Shinozuka, Rose, and Eguchi, 1998). More recently, the National Research Council Committee on Assessing the Costs of Natural Disasters published a report outlining a framework for loss estimation (National Research Council, 1999). The HAZUS methodology, developed by the National Institute of Building Sciences with funding from the Federal Emergency Management Agency, is currently one of the best-known set of loss estimation techniques (National Institute of Building Sciences, 1997). Further advances in loss estimation research have been facilitated by new geographic information system (GIS) mapping techniques, as well as by the growing body of empirical data on the physical and economic effects of recent earthquakes.

Providing better estimates of potential earthquake losses is extremely challenging, because of shortages in the kinds of empirical data that are

Collaborative Partners

- MCEER investigator **Ronald Eguchi** has established close working relationships with the California Governor's Office of Emergency Services and with the City of Los Angeles, which have used damage assessment and decision support systems developed by EQE in responding to the 1994 Northridge earthquake, in emergency response training, and in mitigation decision making.
- In related work, with funding from the joint federal-state TriNet program, EQE, the University of Delaware Disaster Research Center, and the University of California, Los Angeles have recently begun to undertake research on the feasibility of implementing a real-time earthquake warning system for the southern California region.
- MCEER investigator **Adam Rose** has been working with Colorado State University economist **Harold Cochran** on improving methods for indirect loss modeling.
- Members of the loss estimation group also work closely with **Howard Kunreuther**, an MCEER investigator at the Wharton School, who will be undertaking benefit/cost analyses for alternative mitigation measures.

needed for more accurate estimates, our limited understanding of the mechanisms through which losses are generated and of the risk factors associated with loss, and the uncertainties that enter into loss calculations at various stages. The MCEER loss estimation research team has attempted to address these problems by systematically reviewing selected loss estimation methodologies, identifying areas where improvements are needed, and conducting new research on earthquake losses. These investigations center on four inter-related topics:

- use of advanced technologies for real-time damage and loss estimation;
- measurement and estimation of direct physical and economic losses;
- identification of risk factors for business losses, including both physical and business interruption losses; and
- estimation of indirect or induced economic losses

This paper briefly summarizes work that has been undertaken to date in each of these four areas.

Advanced Technologies in Real-Time Damage Assessment

This phase of MCEER's research focuses on improving loss estimation for earthquake preparedness, response, and mitigation through the application of new technologies that collect and analyze information on the built environment more efficiently, rapidly, and economically. The availability of accurate and timely information on post-event damage is one of the most critical factors influencing the effectiveness of post-disaster response efforts. The rapid deployment of resources where they are most needed cannot take place unless a comprehensive picture of damage is available. The concept of real-time damage assessment in the U.S. began roughly eight years ago with the introduction of the CUBE (Caltech-USGS-Broadcast of Earthquakes) system in southern California (see CUBE, 1992). About four years ago, a similar system, REDI (Rapid Earthquake Data Integration) was set up in northern California.

Both probabilistic and scenario-based loss estimates are being used as planning tools in the pre-earthquake context, e.g., to provide forecasts of likely physical impacts. Loss estimation methodologies are also being applied to aid mitigation decision making through making it possible to determine the cost-effectiveness of alternative mitigation strategies. With the advent of real-time damage- and loss-estimation tools, loss estimation methodologies also have the potential for use in guiding emergency response and early recovery activities, such as search and rescue, the provision of emergency shelter, and decision making with respect to lifeline restoration. Users of loss estimation research and techniques include federal, state, and local policy makers and planners, the emergency management community, and various private-sector groups, particularly those in the financial, insurance, and real estate sectors.

Future developments, as part of the CUBE/TriNet program, will include real-time ground motion maps and a real-time warning system based on early detection of earthquakes.

Although they provide valuable earthquake information, the CUBE and REDI systems stop short of estimating the damaging effects of earthquakes. To fill this need, a number of earthquake researchers have developed software tools based on conventional loss estimation methodologies that can generate loss estimates from earthquake magnitude data (Eguchi et al., 1997). However, in the last several years, a new set of technologies based on remote sensing methods have found their way into disaster management. One of the first examples of a remote sensing application to earthquake hazards was provided by Dr. Robert Crippen of the Jet Propulsion Laboratory (JPL) in Pasadena (Crippen, 1992; Crippen and Blom, 1993). Using SPOT¹ satellite images acquired approximately one month after the 1992 Landers earthquake, JPL captured the spatial details of terrain movements along fault breaks associated with the earthquake that were virtually undetectable by any other means. These changes, seen in Figure 1, allowed displays of fault location, patterns of drag and block rotation, and pull-apart zones to be revealed. Additionally, separate applications of correlation analysis (i.e., image matching) on each side of the fault provided a comprehensive and quantitative estimate of

the total slip (magnitude and direction) across all strands, warps, and other areas across the fault zone.

Synthetic Aperture Radar (SAR) is another promising technology that extends the applicability of satellite-based or airborne systems to post-earthquake analysis. When used to compare before and after radar images of earthquake impacted areas, these methods have been effective in identifying regions of widespread ground displacement. Figure 2 presents colored images of the co-seismic displacements that were observed after the 1994 Northridge, California, and 1995 Kobe, Japan, earthquakes. In the Northridge image, an interferometric method known as repeat pass interferometry (Gabriel and Goldstein, 1988) was used to quantify the amount of relative displacement recorded after the Northridge earthquake. Figure 2a shows that the highest rates, approximately 60 cm of relative displacement, occurred in the northwestern part of the San Fernando Valley.

Related MCEER Research Activities

- *Los Angeles Water and Power Demonstration Project*
- *Hospital Demonstration Project*
- *Advanced Technologies for Loss Estimation, Development of Damage Functions using Remote Sensing and Real-time Decision Support Systems, R.T. Eguchi, EQE International and D.M. Tralli, MCEER Consultant*
- *Cost-Benefit Studies of Rehabilitation Using Advanced Technologies, R. Eguchi, EQE International, P. Kleindorfer and H. Kunreuther, University of Pennsylvania, M. Shinozuka, University of Southern California and K. Tierney, University of Delaware*

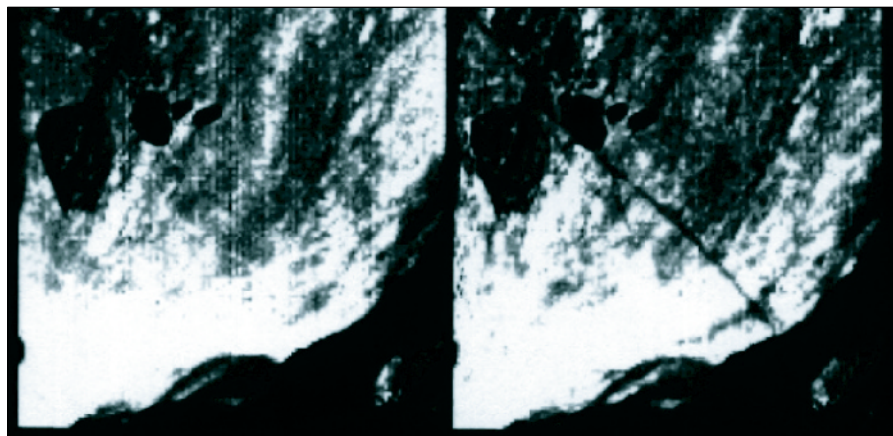

Image produced by Dr. Robert Crippen, Jet Propulsion Laboratory, Pasadena.

■ **Figure 1.** Landers Earthquake Ground Cracks, Emerson Fault, SW of Galway Lake, Mojave Desert, California. Before Satellite Image (Left) 27 July 1991; After Satellite Image (Right) 25 July 1992. Scale: 1.28 km across fault (upper left to lower right).

“Synthetic Aperature Radar is another promising technology that extends the applicability of satellite-based or airborne systems to post-earthquake analysis.”

In the Kobe earthquake, a similar interferometric image was constructed using pre- and post-earthquake SAR images. In Figure 2b, each cycle of color corresponds to about 12 cm change in distance between the satellite and the ground surface. Both studies used images obtained by JERS²-1. SAR also has the advantage of imaging through cloud cover and during nighttime conditions, thus making it applicable in real-time.

MCEER investigator Ronald Eguchi is currently exploring the application of remote sensing methods for real-time post-impact damage assessment (see *A New Application for Remotely Sensed Data: Construction of Building Inventories Using Synthetic Aperature Radar Technology* in this report). While the applications described above provide useful post-earthquake data, they fail to explain fully the changes in the post-earthquake images. Data are limited to differential measurements of elevation and scattering³ based on repeat passes (pre- and post-event) over the subject area. In general, the observer does not know whether these changes are due to surface displacement, building damage, or a combination of these two effects. MCEER’s research focuses on differentiating between these effects by introducing other independent data and

models that allow a validation/calibration of SAR parameters. For example, GPS measurements can provide site or regional validations that surface displacement has occurred. Optical images created by aerial photographs or satellite imaging (e.g., SPOT) can provide important verification that damage has or has not occurred. In addition, new simulation models that replicate SAR images through analytical techniques can be used to help quantify building damage on a local level. In combination, these technologies will provide a powerful tool that can quickly and reliably assess damage on a large regional scale. With such systems in place, emergency responders can act more decisively after a major event, reducing overall response times, saving lives, and containing property losses.

Complementing this work, which is designed to detect damage at a

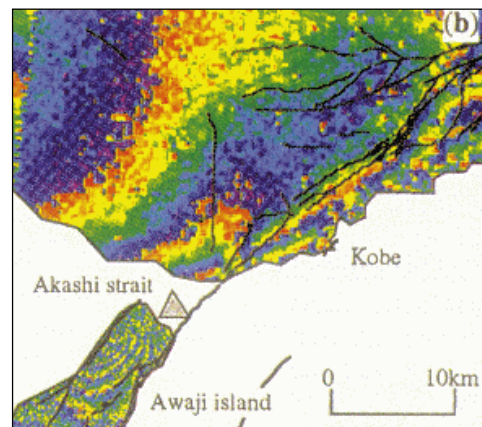

Kobe Image from Ozawa et al., 1997

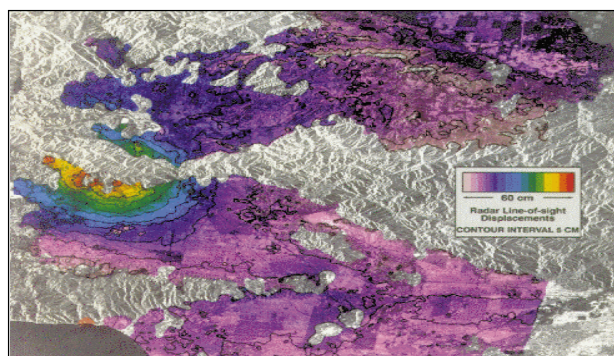

Northridge Earthquake image provided by Dr. Paul Rosen (JPL)

■ Figure 2. Interferograms Showing Relative Ground Displacements Measured After the 1994 Northridge and 1995 Kobe Earthquakes. Each color change reflects an increase or decrease in constant ground displacement. Note that the color scales are different in each figure.

more macro-level, MCEER investigator Masanobu Shinozuka has been using SAR imaging to focus more closely on specific structures. In his research, several buildings on the University of Southern California's main campus are being modeled using Auto-CAD and MATLAB, with possible future use of ARC/INFO's 3D Analyst. SAR approaches will be applied in simulation and completed for some buildings. Computations are currently being carried out for a grouping of buildings, introducing changes that resemble earthquake damage.

SAR operates by shooting a bundle of many thousand rays at an object. The rays interact with the structure at its boundaries, with attendant reflections and refractions. Rays penetrate the material and may bounce several times before exiting an object. Thus, structures and their edges are usually readily detectable using this technology. Simulated SAR images can be projected on a slant plane, ground plane, and on a plane vertical to the slant plane. The vertical image projection, which is used for diagnostic purposes, reveals height changes most directly. Due to "layover," the fact that higher objects appear closer in a radar image but further away in a photograph, buildings are skewed in a predictable manner. Geometrical changes, such as tilting, overturning, or pancaking can be observed and measured through the use of SAR, as shown in Figure 3. The height and straightness of buildings can be deduced using these measures. Taller buildings cast longer shadows, and thicker horizontal contour edges at the front of structures are another indication of building height, as indicated in Figure 4. This type of analytic research on individual

structures is an essential step in developing macro-level or regional damage models, because in the absence of SAR-derived empirical data, it is necessary to compile catalogues of images that accurately depict a range of possible damage states.

This new approach to loss estimation is consistent with two of MCEER's primary program goals: its emphasis on advanced technology and its commitment to multidisciplinary research. For the first time, a combination of advanced technologies (satellite imaging, Global Positioning Systems, real-time ground motion mapping, advanced simulations, and geographic information systems) is being employed to develop a real-time damage assessment system. This research not only represents an integrated interdisciplinary effort, but it also serves as an example of effective and coordinated technology transfer—in this case, transfer of NASA technology and products.

Direct Losses

Recent disasters such as the Northridge and Kobe earthquakes have demonstrated the importance of evaluating not only the physical

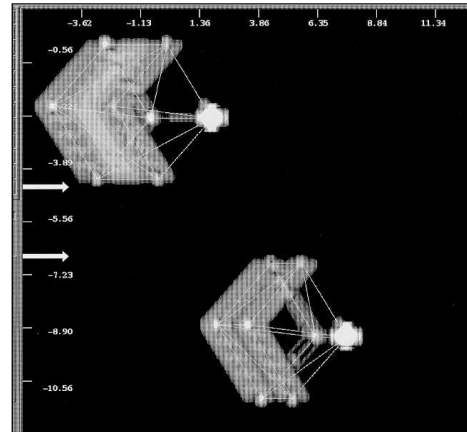

■ Figure 3. Simulated SAR image of two boxes in a slant plane (15 cm resolution)

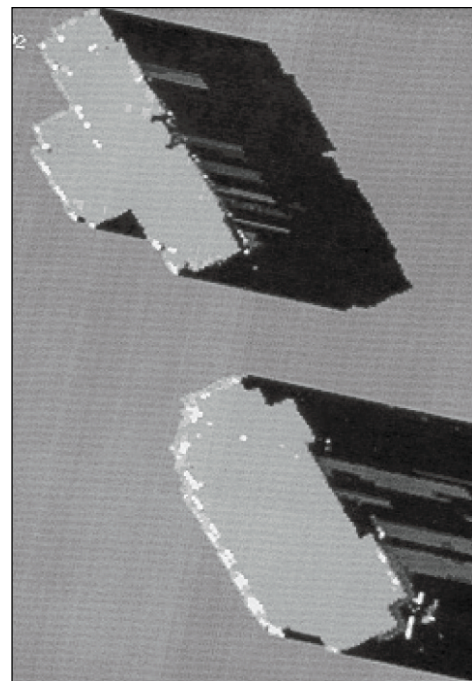

■ Figure 4. Simulated SAR images of two buildings on the University of Southern California Campus

damage that future earthquakes may cause, but also the losses to urban and regional economies caused by that damage, particularly those resulting from damage to urban lifeline systems. In its Los Angeles Department of Water and Power (LADWP) demonstration project, MCEER will be developing an innovative loss estimation methodology for urban lifeline systems that pays particular attention to assessing disruption to the economies of affected areas. This methodology will build on MCEER's previous multidisciplinary work on Memphis Light, Gas and Water (MLGW) Division's utility systems (Shinozuka, Rose, and Eguchi, 1998). Initial efforts have focused on reviewing recent developments in earthquake loss estimation,

developing a "benchmark" dataset of empirical loss data in recent disasters, and developing an improved methodology that can be applied in the LADWP project (see *Seismic Performance Analyses of Electric Power Systems* in this report). These investigations focus in particular on the direct economic loss component of an integrated loss estimation methodology. In this research, the term direct economic loss refers to the disruption to economic activity that is caused by lifeline service outage at the site of production.

MCEER investigator Stephanie Chang has conducted a systematic review of twelve methodologies that evaluate losses related to water lifeline systems and that have made innovations in predicting water service disruption ("outage") and/or the ensuing economic impacts. This group of studies ranges from consulting projects for individual utility systems to nationally applicable, fully software-implemented methodologies. Table 1 summarizes major noteworthy innovations and remaining methodological gaps identified in this review, according to various technical areas within a comprehensive loss estimation methodology. The specific methodologies included in the review are listed in the footnote to the table. Innovations made in the MCEER Memphis lifeline loss estimation methodology are identified in italics.

The review found that among current loss estimation methodologies, the approach taken in the

■ Table 1. Lifeline Loss Estimation State-of-the-Art: Innovations and Gaps^(a)

Methodological Area	Noteworthy Innovations ^(b)	Remaining Gaps
Uses of Loss Estimation	Service goals and priorities introduced; <i>GIS</i>	Service goals and priorities rigorously integrated
Repair Cost		Standardized repair cost data/method
Systems Analysis and Outage	<i>Flow analysis for damaged system; variable demand</i>	Lifeline interaction; full integration with socio-economic analysis
Restoration	Repair demand/capacity method; optimized restoration sequencing	Standardized demand/capacity data
Secondary Loss	Fire-fighting capacity (preliminary)	Water serviceability link to fire following earthquake
Social Impacts	Populations affected; critical facilities served	Link to economic impacts
Economic Impacts	<i>Utility revenue loss; direct and indirect regional economic loss; reconstruction stimulus</i>	Integration with engineering systems analysis
Uncertainty	<i>Monte Carlo simulation of damage</i>	Quantification of uncertainty throughout methodology

Notes: (a) Based on review of the following 12 methodologies: HAZUS (NIBS, 1997; Whitman et al., 1997), CUREe model (Kiremidjian et al., 1997), PIPELINE-FIX (French and Jia, 1997), NCEER model (Rose et al., 1997; Chang et al., 1996; Shinozuka, 1994; Koiwa et al., 1993), IRAS (RMS, 1995), EBMUD study (G&E, 1994), VRWater (Cassaro et al., 1993), ATC-25-1 (ATC, 1992), ASCE/TCLÉE methodology (Taylor, 1991), K/J/C Everett study (Ballantyne and Heubach, 1991), K/J/C Seattle study (Ballantyne, 1990), and Boston study (URS/Blume, 1989); (b) *Italics* identify innovations made in the MCEER Memphis model.

MCEER Memphis study incorporated numerous innovations in terms of modeling water outage and associated regional economic impacts. That approach thus provides an excellent basis for further development in the LADWP demonstration project. However, several significant improvements can be made by learning from other current methodologies, in particular by introducing explicit system service goals/priorities, adopting current models of post-disaster system restoration, and evaluating social impacts and implications for fire following earthquake. Furthermore, many gaps remain, even in state-of-the-art approaches. One of the most critical economic loss modeling shortfalls that will need to be addressed in MCEER's LADWP project is full integration of engineering systems analysis with economic analysis. While the Memphis study made important contributions toward such integration, improvements are still needed. For example, in that model, lifeline outage is modeled probabilistically, while economic loss is modeled deterministically.

As a first step in further refining direct loss estimates, MCEER is conducting further analyses on the Memphis lifeline system. This approach takes advantage of existing data while allowing time for the development of databases for the LADWP demonstration project. Figure 5 outlines the refined methodology for estimating direct losses that is currently under development.

The enhancements incorporated into this new approach to modeling direct losses include the following:

- Integration of economic loss modeling within the Monte Carlo simulation process. This

allows not only damage, but also economic loss, to be estimated on a probabilistic basis, producing a “seamless” loss estimation model.

- Incorporation of the spatial and temporal dimensions of loss through improved restoration

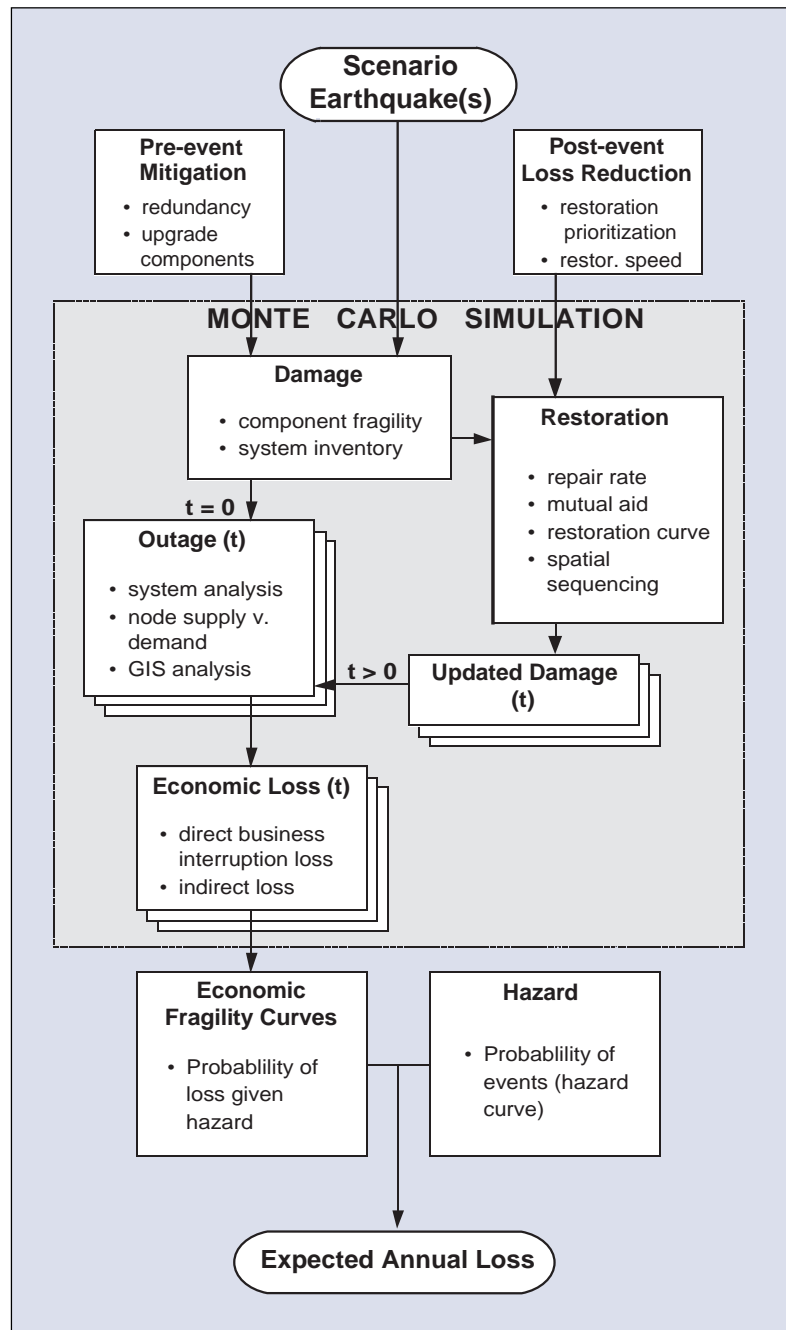

■ Figure 5. Flowchart of Refined Methodology for Estimating Direct Losses Due to Lifeline Disruption

“This new approach to loss estimation is consistent with two of MCEER’s primary program goals: its emphasis on advanced technology and its commitment to multidisciplinary research.”

modeling. This approach makes it possible to explore how post-event strategies such as spatially prioritizing restoration using GIS methods can reduce total economic loss.

- Development of “economic fragility curves.” As with component fragility curves, which indicate the probability of exceeding a given damage state for various levels of ground motion, an economic fragility curve would indicate the probability of exceeding a given level of loss for various earthquake magnitudes. Results can be integrated with probabilistic hazard information to derive expected annual loss estimates, which are necessary for cost/benefit analysis of loss reduction measures.

This approach parallels the methodology developed by Shinozuka and Eguchi (1998). The refined model will be applied to simulating and comparing the direct loss-reduction benefits of various mitigation strategies, ranging from pre-disaster system upgrading through post-disaster mutual aid and optimized restoration.

Finally, in this phase of MCEER’s work on loss estimation, efforts are also being made to develop a benchmark dataset of losses from historic disasters that can be used in the validation and calibration of future loss estimation methodologies. To date, disaster loss data have been fragmented, inconsistently defined, and incomplete, and the goal of MCEER’s research is to collect, reconcile, and compare empirical data on the regional economic impacts of earthquakes, focusing primarily on the U.S. and Japan.

Business-Level Losses

Research to identify and quantify the factors that predict earthquake-related business losses can enhance our understanding of the processes leading to economic loss and can also point to ways of reducing losses through appropriate mitigation, response, and recovery measures. Existing loss estimation methodologies have by and large not concentrated on investigating firm-level earthquake impacts or on isolating the most significant contributors to business loss. Most efforts at estimating losses focus on the aggregate or regional level, rather than on populations of business firms. Research in this area, which is being conducted at the University of Delaware’s Disaster Research Center (DRC), builds upon the Center’s earlier work on business vulnerability and earthquake-induced business losses (Tierney, 1997; Dahlhamer and Tierney, 1998; Tierney and Dahlhamer, 1998a, 1998b).

DRC’s most recent analyses on risk factors for business loss have focused on predicting dollar losses due to both physical damage and business interruption using data collected from large samples of businesses affected by the 1989 Loma Prieta and 1994 Northridge earthquakes. These analyses use several types of predictor variables: business-level characteristics, including business size and economic sector; measures of lifeline service disruption; peak ground acceleration (PGA); and the age of the structure housing the business. (Data on PGA and building age are currently available only for Los Angeles and Santa Monica; those data will be incorporated into Santa Cruz County analyses when they become available.)

■ Table 2. Regression (OLS) Results for Total Dollar Losses

Variable	Santa Cruz			Northridge (initial)			Northridge (full)		
	Unstd. Coeff.	SE	Std. Coeff.	Unstd. Coeff.	SE	Std. Coeff.	Unstd. Coeff.	SE	Std. Coeff.
Full-time Employees (ln)	.27***	.04	.24	.15***	.03	.15	.16***	.03	.17
Wholesale or Retail	.41**	.13	.13	.57***	.13	.16	.54***	.13	.15
Finance, Insurance, or Real Estate	.12	.20	.02	.62***	.16	.13	.57**	.17	.12
Services	.27*	.13	.09	.39**	.12	.12	.31*	.13	.10
Loss of Electricity	.40*	.19	.08	.88***	.12	.28	.85***	.13	.28
Loss of Telephones	.17	.13	.05	.27*	.12	.09	.19	.12	.06
Loss of Water	.57***	.11	.20	1.02***	.12	.27	.77***	.13	.20
Peak Ground Acceleration	--	--	--	--	--	--	1.62***	.25	.22
Year Built (1960-76)	--	--	--	--	--	--	.11	.11	.03
Year Built (Post-1976)	--	--	--	--	--	--	.22	.12	.07
N	725			852			719		
R ²	.14			.29			.33		
F-value	16.69***			48.20***			35.55***		

*p<.05 **p<.01 ***p<.001

Table 2 presents the results of analyses that have been conducted to assess the differential impact of this group of factors on business losses. The table summarizes findings for three regression analyses: separate models for Northridge and Santa Cruz using business-level and lifeline disruption variables, and a more complete model for the Northridge data that incorporates PGA and building data. Five significant predictors of business losses have been identified in this series of analyses. In both study areas, business size is a significant predictor of total dollar loss, with larger firms reporting greater losses than their smaller counterparts. However, the relationship was more pronounced among Santa Cruz County businesses.⁴

Business sector also plays an important role in predicting total dollar losses, with wholesale and retail businesses and service firms reporting greater losses following both

earthquakes than manufacturing and “other” establishments. Lifeline outages also had a significant influence on total dollar losses. Businesses that lost electricity reported significantly greater losses in both study communities, as did firms losing water service. This relationship was particularly pronounced in the Northridge sample. Telephone service disruption was also an important predictor of losses among Northridge firms, with businesses losing telephones incurring significantly higher losses.

Another way of looking at the relationship between the interruption of lifelines and dollar losses is to consider the duration of outage and its impact on loss. While the initial impact of lifeline disruption may not be felt immediately, MCEER’s analyses show that there is a ramping up of dollar losses as lifeline outages continue. As illustrated in Figure 6, among Northridge businesses, losses remained fairly low up to

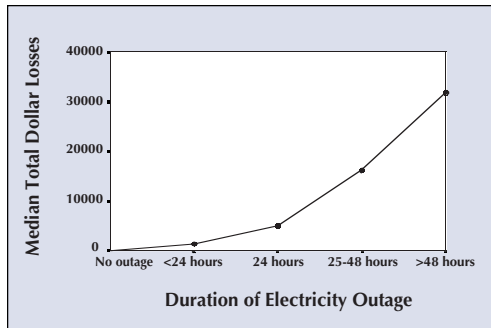

■ Figure 6. Median Total Dollar Losses by Duration of Electricity Outage (Northridge)

twenty-four hours of electricity outage, but after that time losses began to escalate. Similar patterns were observed for telephone and water loss following the Northridge event, although the data also suggest that any interruption of water

service tends to be costly for businesses. These findings point to the importance of mitigation and rapid restoration measures for lifeline systems as strategies for containing economic losses.

Returning to Table 2, additional analyses were conducted with the Northridge data, incorporating data on PGA as a measure of earthquake shaking, as well as on the time period in which the buildings housing businesses were constructed, to take into account structural vulnerabilities. PGA emerged as the second strongest predictor of total dollar loss. Not surprisingly, firms located in areas experiencing more intense shaking reported overall greater losses. While almost nonexistent at low levels, losses substantially increase with higher ground acceleration levels.

While not reaching statistical significance, the relationship between building age and total dollar losses is interesting and somewhat counterintuitive. Firms housed in buildings constructed after 1976 reported much greater losses than those located in building constructed between 1960 and 1976 or prior to 1960. Contrary to what might be expected, businesses operating in newer structures sustained the highest losses among all firms in the sample. This relationship is likely due to the fact that

structures in the area near the epicenter of the Northridge earthquake, which experienced the strongest shaking, tended to be of relatively recent vintage. Parts of the impact region that had a greater concentration of older buildings experienced less shaking in this particular event.

Studies that focus on risk factors for loss at the firm level contribute to loss estimation methodologies in several ways. First, they identify variables that need to be taken into account in the development of aggregate regional direct and indirect loss models. Second, they provide insights into the relative importance of different factors that contribute to losses, such as ground motion and lifeline disruption. And relatedly, they provide data that can be used to better calibrate the assumptions made in regional loss models. More generally, they serve as a bridge between modeling efforts that focus on direct physical impacts and those that attempt to estimate indirect or induced economic losses, which are discussed in the section that follows.

Indirect Economic Losses

Indirect losses, defined here as the difference between total business interruption losses that propagate through the economy and the direct losses stemming from physical damage caused by ground shaking, are usually measured in terms of the interruption of flows in the production of goods or services. Such losses are typically distinguished from indirect physical damage and ensuing business disruption, due, for example, to fires in the aftermath of an earthquake. While property damage is generally immediate, business

interruption losses can last months and even years. Whether indirect losses proliferate depends considerably on the speed and extent of recovery and reconstruction efforts.

Input-output (I-O) analysis is the most widely used approach to estimating indirect losses resulting from earthquakes and other hazards. In its most basic form, I-O is a static, linear model of all purchases and sales between sectors of an economy, based on the technical relations of production (Rose and Miernyk, 1989). I-O models are especially adept at calculating multiplier effects (Kawashima and Kanoh, 1990; Gordon, et al., 1998), and empirical models are widely available for any county or county grouping of the U.S. through the Impact Analysis for Planning (IMPLAN) System, developed by FEMA and several other federal government agencies (see Minnesota IMPLAN Group, 1998). However, in its more basic forms, I-O is extremely rigid, incapable of incorporating the resiliency often observed in the aftermath of hazard events, and lacking in behavioral content.

There are several alternatives to I-O analysis. One alternative, mathematical programming models of an entire economy, adds to an I-O table an objective function to be optimized, as well as various resource constraints (Rose, 1981; Cole, 1995). This framework, which is able to incorporate substitution possibilities on both the supply and demand sides, has proved to be especially useful in analyses of how to minimize indirect losses (see, e.g., Rose et al., 1997). However, like I-O analysis, it fails to incorporate behavioral considerations associated with decision making.

Another modeling approach, econometric estimation, ranges from studies of individual sectors, such as the real estate market (Ellson et al., 1984), to the entire economy (Guimares et al., 1993). Econometric models have much sounder statistical properties than other modeling approaches. However, since these analyses are typically based on time series data, they often represent extrapolations of past behavior and thus are not especially adept at modeling the disjointed nature of hazard impacts.

MCEER is currently investigating another category of approaches, computable general equilibrium (CGE) models. CGE analyses employ multi-market simulation models based on the simultaneous optimizing behavior of individual consumers and firms, subject to economic account balances and resource constraints (see Shoven and Whalley, 1992). Prior to research by MCEER investigator Adam Rose, the only applications of CGE models to hazard analysis were pedagogical overviews or pilot applications (see, e.g., Boisvert, 1992; Brookshire and McKee, 1992).

CGE models can incorporate the best features of the other modeling approaches. They are typically based on an I-O table of detailed production data and a social accounting matrix (SAM) extension of double entry accounts of institutions such as households, corporations, and trade balances. CGE models have an optimizing feature, but it is based on the interaction of individual firms and consumers. Moreover, the major parameters of CGE models can be statistically estimated or can be based on engineering studies.

Constructing and Applying a CGE Model

In modeling the effects of natural hazards, analysts must first set the stage by identifying key characteristics, which provide the basis for specifying assumptions and causal relationships of the analytical model. The characteristics for two different contexts are enumerated in Table 3. For example, characteristics 1 through 3 have implications for the extent and aggregation of capital asset variables in the model. They also identify the conduit through which impacts manifest themselves, or, more practically, indicate which variables are affected by the event. The capital asset variables also raise an important distinction. The terms *short run* and *long run* pertain to the standard economic distinction between the period when some inputs (usually capital) are fixed and the period when all inputs are variable. In relation to hazards, the former refers to the time of the hazard event and its immediate

aftermath, while the latter pertains to the period of reconstruction.

A prototype CGE model has been constructed for Shelby County, Tennessee, in order to simulate the impacts of a New Madrid earthquake on the city of Memphis. The model is patterned after a similar construct for the Susquehanna River Basin developed by MCEER investigator Adam Rose to analyze the indirect economic impacts of flooding (Rose et al., 1998) and structured to be comparable to input-output and linear programming models previously used by Rose to estimate the indirect impacts of a New Madrid earthquake (see Rose et al., 1997). The model consists of 22 production sectors, with an emphasis on those that are major users of electricity lifelines and those that are most crucial to the functioning of the regional economy.

The model is currently being applied to the simulation of direct and indirect economic impacts from a 7.5 magnitude earthquake in the New Madrid area, using data on electricity lifeline system vulnerability

■ Table 3. Key Considerations in Modeling the Economic Impacts of Earthquakes

Short Run	Long Run
1. Capital stock is reduced immediately.	1. Rebuilding of capital stock takes time.
2. Loss is concentrated in man-made capital.	2. Rebuilding often includes mitigation measures.
3. Damage manifests itself through capacity reduction.	3. Damage stops when capacity is rebuilt or institutions are rearranged.
4. Disequilibrium is pervasive.	4. Equilibrium is re-established.
5. Losses are usually regionally isolated.	5. Other regions lose if aid is not repaid.
6. Production is curtailed.	6. Some or all of production can be recaptured.
7. Some prices may rise.	7. Prices are likely to return to previous levels.
8. New input combinations are used.	8. Some input combination changes may persist.
9. Imports are a major stop gap.	9. Imports return to pre-disaster norm or revised pattern.
10. Use of savings provides an economic boost.	10. Use of savings in short run is a long run drain.
11. Gov't recovery aid provides an economic boost.	11. Gov't reconstruction aid provides an economic boost.
12. Insurance payments provide a boost.	12. Insurance options will decline if losses increase.
13. Recovery may require some central planning.	13. Reconstruction is helped by planning (including incentive based).
14. Modest uncertainty exists.	14. Uncertainty declines.
15. Decision-making is myopic because of immediate needs.	15. Decision-making somewhat myopic because of infrequency of events.

and direct economic losses from previous MCEER research (Shinozuka, Rose, and Eguchi, 1998). Additionally, data from MCEER's earlier Loss Assessment of Memphis Buildings (LAMB) study (Chang and Eguchi, 1997) are being used as the basis for estimates of broader business interruption and ensuing direct effects. Sensitivity tests will be performed related to assumptions on the main parameters of input and import substitution, factor mobility, recovery timing, and insurance/aid payment levels.

Future Research Activities

Two new research activities are being undertaken as part of this component of MCEER's research program. The first is a meta-analysis of factors influencing direct and indirect losses from natural hazards. Meta-analysis is a statistical technique that summarizes and synthesizes the results of individual studies. The literature is being reviewed to identify causal factors, and additional data are being collected. Multiple regression estimates will yield prime determinants, which in turn will be used to specify important relationships in future computable general equilibrium models.

In addition, a CGE model for Los Angeles will be constructed and will be applied to analyzing the direct and indirect economic impacts of disruptions of utility lifeline services as part of MCEER's Los Angeles lifeline demonstration project. This multidisciplinary research will also incorporate mitigation considerations so as to fit into the overall cost-benefit analysis framework that MCEER investigator Howard Kunreuther is developing (see Kunreuther, 1999).

Conclusion

MCEER's research on earthquake loss estimation builds upon collaborations among engineers and social scientists that were initiated during its first ten years as the National Center for Earthquake Engineering Research. This multidisciplinary approach, which is demonstrated in the 1998 MCEER monograph on the economic impacts of lifeline disruption in the central U.S. (Shinozuka, Rose and Eguchi, 1998), begins with an understanding of seismic hazards and continues with analyses that quantify the vulnerability of engineered systems and the ways in which the physical impacts of earthquakes on those systems subsequently affect economic activity, producing losses that ripple outward through affected regional economies. Consistent with its emphasis on the use of advanced technologies in earthquake loss reduction, a second major theme in MCEER's groundbreaking loss estimation research centers on the ways in which technologies originally developed for other purposes—in this case, remote-sensing technologies—can be used to assess the vulnerability of the built environment and to improve the speed and quality of crisis decision making.

Future research will focus on collecting additional data, systematizing what is known about earthquake-related losses, and further refining and calibrating loss models. The methods developed by loss estimation researchers will be applied in MCEER's demonstration projects and linked with other investigations that focus on assessing the costs and benefits of mitigation strategies for critical facilities and lifelines.

Endnotes

- ¹ SPOT is a company that provides satellite imagery data throughout the world. SPOT stands for Satellite Pour l'Observation de la Terra.
- ² JERS is the satellite system operated in Japan.
- ³ Scattering describes the physical process that occurs when radar signals are reflected back from the earth's surface to the sensor. The degree of scattering depends on the surface cover, e.g., type of vegetation, and the type of development.
- ⁴ While larger firms sustained greater overall financial losses, the impacts are more devastating to smaller businesses when losses are calculated on a per-employee basis. Standardized in this manner, small businesses report greater median losses than larger ones. Small Santa Cruz firms reported median per employee losses of \$1,000, as compared with their larger counterparts, whose per capita losses were \$352. The figures for Northridge for small and large firms were \$851 and \$31, respectively.

References

- Applied Technology Council (ATC), (1992), *A Model Methodology for Assessment of Seismic Vulnerability and Impact of Disruption of Water Supply Systems*, Report No. ATC-25-1, Redwood City, California.
- Ballantyne, D.B., (1990), *Earthquake Loss Estimation Modeling of the Seattle Water System*, Report to the U. S. Geological Survey, Federal Way, Washington, Kennedy/Jenks/Chilton.
- Ballantyne, D.B. and Heubach, W.F., (1991), *Earthquake Loss Estimation for the City of Everett, Washington Lifelines*, Federal Way, Washington, Kennedy/Jenks/Chilton.
- Boisvert, R., (1992), "Indirect Losses from a Catastrophic Earthquake and the Local, Regional, and National Interest," *Indirect Economic Consequences of a Catastrophic Earthquake*, National Earthquake Hazards Reduction Program, Federal Emergency Management Agency, July, pp. 204-266.
- Brookshire, D. and McKee, M., (1992), "Other Indirect Costs and Losses from Earthquakes: Issues and Estimation," *Indirect Consequences of a Catastrophic Earthquake*, National Earthquake Hazards Reduction Program, Federal Emergency Management Agency, July, pp. 267-325.
- Cassarro, M.A., Cassaro, M.J. and Ragade, R.K., (1993), *Facility Management and Risk-Based Decision Support for Water Delivery Utilities Subject to Natural Hazards*, Center for Hazards Research and Policy Development, University of Louisville, Louisville, Kentucky.
- Chang, S. and Eguchi, R., (1997), "Estimating Losses," *Loss Assessment of Memphis Buildings*, D.P. Abrams and M. Shinozuka (Eds.), Technical Report NCEER-97-0018, Multidisciplinary Center for Earthquake Engineering Research, Buffalo, New York.
- Chang, S.E., Seligson, H.A. and Eguchi, R.T., (1996), *Estimation of the Economic Impact of Multiple Lifeline Disruption: Memphis Light, Gas, and Water Division Case Study*, Technical Report NCEER-96-0011, Multidisciplinary Center for Earthquake Engineering Research, Buffalo, New York.
- Cole, (1995), "Lifelines and Livelihood: A Social Accounting Matrix Approach to Calamity Preparedness," *Journal of Contingencies and Crisis Management*, Vol. 3, pp. 1-11.
- Crippen, R.E., (1992), "Measurement of Subresolution Terrain Displacements using SPOT Panchromatic Imagery," *Episodes*, Vol. 15, No. 1.

- Crippen, R.E. and Blom R.G., (1993), "Mapping of the Horizontal Strain Field of the 1992 Landers Earthquake by Imageodesy," *EOS Transactions of the American Geophysical Union*, Vol. 73, No. 43, pp. 374.
- CUBE, (1992), *CUBE Handbook - Third Draft*, Caltech-UGSG- Broadcast of Earthquakes.
- Dahlhamer, J.M. and Tierney, K.J., (1998), "Rebounding from Disruptive Events: Business Recovery Following the Northridge Earthquake," *Sociological Spectrum*, Vol. 18, pp. 121-141.
- D'Ayala, D., Spence, R., Oliveira, C. and Pomonis A., (1997), "Earthquake Loss Estimation for Europe's Historic Town Centers," *Earthquake Spectra*, Vol. 13, No. 4, pp. 773-793.
- Eguchi, R.T., Goltz, J.D., Seligson, H.A., Blais, N.C., Heaton, T.H. and Burtugno, E., (1997), "Real-Time Loss Estimation as an Emergency Response Decision Support System: The Early Post-Earthquake Damage Assessment Tool (EPEDAT)," *Earthquake Spectra*, Vol. 13, No. 4, pp. 815-832.
- Ellson, R., Milliman, J. and Roberts, R., (1984), "Measuring the Regional Economic Effects of Earthquakes and Earthquake Prediction," *Journal of Regional Science*, Vol. 24, pp. 559-79.
- French, S.P. and Jia, X., (1997), "Estimating Societal Impacts of Infrastructure Damage with GIS," *URISA Journal*, Vol. 9, No. 1, pp. 31-43.
- G&E Engineering Systems, Inc., (1994), *East Bay Municipal Utility District Seismic Evaluation Program, Final Report*, Oakland California.
- Gabriel, A.K. and Goldstein R.M., (1988), "Repeat Pass Interferometry," *International Journal of Remote Sensing*, Vol. 9, pp. 857-872.
- Gordon, P., Richardson, H. and Davis, B., (1998), "Transport-Related Impacts of the Northridge Earthquake," *Journal of Transportation and Statistics*, Vol. 1, pp. 22-36.
- Guimaraes, P., Hefner, F. and Woodward, D., (1993), "Wealth and Income Effects of Natural Disasters: An Econometric Analysis of Hurricane Hugo," *Review of Regional Studies*, Vol. 23, pp. 97-114.
- Kawashima, K. and Kanoh, T., (1990), "Evaluation of Indirect Economic Effects Caused by the 1983 Nihonkai-Chubu, Japan, Earthquake," *Earthquake Spectra*, Vol. 6, pp. 739-56.
- Kiremedjian, A.S., King, S.A., Basöz, N.I., Law, K.H., Vucetic, M., Doroudian, M., Iskandar, V., Olson, R., Eidinger, J., Koettel, K. and Horner, G., (1997), *Methodologies for Evaluating the Socio-Economic Consequences of Large Earthquakes*, John A. Blume Earthquake Engineering Center, Stanford University, Palo Alto, California.
- Koiwa, H., Tanaka, S., Shinozuka, M. and Hwang, H.H.M., (1993), "GIS Applications for a Water Delivery System Under Intact and Seismically Damaged Conditions," *Lifeline-W(1) User's Guide*, unpublished report, Multidisciplinary Center for Earthquake Engineering Research, Buffalo, New York.
- Kunreuther, H., (1999), *The Role of Benefit-Cost Analysis in Evaluating Protective Measures*, The Wharton School, University of Pennsylvania, Philadelphia, Pennsylvania.
- Minnesota IMPLAN Group, (1998), *Impact Analysis for Planning System (IMPLAN)*, Stillwater, Minnesota.
- National Institute of Building Sciences, (1997), *HAZUS Technical Manual*, National Institute of Building Sciences (HAZUS), Washington, D.C.
- National Research Council, (1999), *The Impacts of Natural Disasters: A Framework for Loss Estimation*, National Academy Press, Washington, D.C.
- Ozawa, S., Murakami, M., Fujiwara, S. and Tobita, M., (1997), "Synthetic Aperture Radar Interferogram of the 1995 Kobe Earthquake and its Geodetic Inversion," *Geophysical Research Letters*, Vol. 24, No. 18, pp. 2327-2330.

- Risk Management Solutions, Inc., (RMS), (1995), "What If the 1923 Earthquake Strikes Again?" *A Five-Prefecture Tokyo Region Scenario*, Risk Management Solutions, Menlo Park, California.
- Rose, A., (1981), "Utility Lifelines and Economic Activity in the Context of Earthquakes," *Social and Economic Impact of Earthquakes on Utility Lifelines*, J. Isenberg (Ed.), American Society of Civil Engineers, New York.
- Rose, A. and Miernyk, W., (1989), "Input-Output Analysis: The First Fifty Years," *Economic Systems Research*, Vol. 1, pp. 229-271.
- Rose, A., Carmichael, J., Oladosu, G. and Abler, D., (1998), *Modeling the Economics of Natural Hazard Impacts and Policy Responses Using Computable General Equilibrium Analysis*, Department of Energy, Environmental, and Mineral Economics, Pennsylvania State University, University Park, Pennsylvania.
- Rose, A., Benavides, J., Chang, S., Szczesniak, P. and Lim, D., (1997), "The Regional Economic Impact of an Earthquake: Direct and Indirect Effects of Electricity Lifeline Disruptions," *Journal of Regional Science*, Vol. 37, pp. 437-58.
- Shinozuka, M., (1994), "GIS Applications in Lifeline Earthquake Engineering," *Proceedings of the Second China-Japan-U.S. Trilateral Symposium on Lifeline Earthquake Engineering*, Xi'an, China, April 19-23, pp. 2232-230
- Shinozuka, M. and Eguchi, R., (1998), "Seismic Risk Analysis of Liquid Fuel Systems: A Conceptual and Procedural Framework for Guidelines Development," *Proceedings of the NEHRP Conference and Workshop on Research on the Northridge, California Earthquake of January 17, 1994*, California Universities for Research in Earthquake Engineering, Richmond, California, pp. 789-796 .
- Shinozuka, M., Rose, A. and Eguchi, R., (eds.), (1998), *Engineering and Socioeconomic Impacts of Earthquakes: An Analysis of Electricity Lifeline Disruptions in the New Madrid Area*, Monograph No. 2, Multidisciplinary Center for Earthquake Engineering Research, Buffalo, New York.
- Shoven, J. and Whalley, J., (1992), *Applying General Equilibrium*, Cambridge University Press, New York.
- Taylor, C.E. (Ed.), (1991), *Seismic Loss Estimates for a Hypothetical Water System*, Monograph No. 2, American Society of Civil Engineers, Technical Council on Lifeline, Earthquake Engineering, New York.
- Tierney, K., (1997), "Business Impacts of the Northridge Earthquake," *Journal of Contingencies and Crisis Management*, Vol. 5, pp. 87-97.
- Tierney, K. and Dahlhamer, J.M., (1998a), "Earthquake Vulnerability and Emergency Preparedness Among Businesses." *Engineering and Socioeconomic Impacts of Earthquakes: An Analysis of Electricity Lifeline Disruptions in the New Madrid Area*, M. Shinozuka, A. Rose and R. T. Eguchi (eds.), Multidisciplinary Center for Earthquake Engineering Research, Buffalo, New York, pp. 53-72.
- Tierney, K. and Dahlhamer, J.M., (1998b), "Business Disruption, Preparedness, and Recovery: Lessons from the Northridge Earthquake," *Proceedings of the NEHRP Conference and Workshop on Research on the Northridge, California Earthquake of January 17, 1994*, Universities for Research in Earthquake Engineering, Richmond, California, pp. 171-178.
- URS Consultants, Inc./John A. Blume and Associates, (1989), *Metropolitan Boston Area Earthquake Loss Study*, URS/Blume, Report prepared for the Massachusetts Civil Defense Agency, San Francisco, California.
- Whitman, R.V., Anagnos, T., Kircher, C., Lagorio, H.J., Lawson, R.S. and Schneider, P., (1997), "Development of a National Earthquake Loss Estimation Methodology," *Earthquake Spectra*, Vol. 13, pp. 643-662.

Benchmark Models for Experimental Calibration of Seismic Fragility of Buildings

by *Andrei M. Reinhorn, Michael C. Constantinou and Dyab Kusumastuti,*
University at Buffalo, State University of New York

Research Objectives

The seismic fragility of buildings is a performance measure, which is difficult to compute. Empirical evaluations require disasters, or field damage, for construction of such fragility, thus, analytical techniques were developed. However, the analytical tools need calibration for either the accuracy of prediction of response, or prediction of damage limit states in engineering terms, both components of fragility. The purpose of this research is to develop a benchmark model, which can be damaged for the above studies, but repairable using inexpensive means for further studies. Moreover, the model should be able to display damage due to irregularities, torsion, setbacks, or other types of damage. The current research was dedicated to the design of the benchmark model and preparations for construction.

The analytical project of MCEER (Tasks 1.5 and 2.5) explored several alternatives to develop fragility information. The fragility is the probability that the **expected response** of a structure, or component, will exceed a **limit state** during an expected **level of ground shaking**. A limit state usually represents, in the same terms as the response, a damage condition or a limitation of usage or other special condition. This analytical project is intended to develop a rational, simplified procedure to calculate fragility curves based on the simplified spectral approach, and verify it with more rigorous alternatives. The development requires:

- Calculation of the expected response after the onset of damage.
- Determining meaningful characteristics of “limit states” and their uncertainties, which are otherwise loosely defined by qualitative methods.
- Redefine the meaningful levels of ground shaking and their representation in fragility analysis.

Several procedures developed to evaluate seismic response and fragility use information at various degrees of detail regarding the structural model and ground motion. The level of detail of the information used determines the uncertainties involved in the resulting fragility curves. The fragility information is therefore developed along with the degrees of confidence

Sponsors

MCEER/NSF

Collaborative Partners

- *At this stage, collaboration with **A.V. Rutenberg**, Technion-Israel Institute of Technology, has begun regarding irregular structures including experimentation and validation of analytical approaches. The research team in Israel is working with other Universities for the European Community (including the University of Bristol, United Kingdom; Universities of Bologna, Florence and Naples, Italy; University of Ljubljana, Slovenia; Technical University of Opole, Poland; University of Bucharest, Romania; and Joint Research Centre in Ispra, Italy). Summer visits for common planning of benchmark models is anticipated.*

Related MCEER Research Activities

- *Hospital Demonstration Project*
- *Calibration of Fragility Estimation and Development of Fragility Information, E. Maragakis and R. Siddharthan, University of Nevada - Reno*
- *Development of Fragility Information, S. Billington, M. Grigoriu and A. Ingraffea, Cornell University, M. Shinozuka, University of Southern California, M.P. Singh, Virginia Polytechnic Institute and A.J. Aref, G.F. Dargush and T.T. Soong, University at Buffalo*
- *Experimental Facilities Network, E. Maragakis, University of Nevada - Reno*

in such information. The target of the analytical studies is a simple method based on nonlinear spectral analysis using *linearized inelastic spectrum* of suites of ground motions and its statistical distribution and a *spectral inelastic capacity model* representation of structure (obtained from static nonlinear analysis) in the presence of uncertainties. The method can be further simplified to use nonlinear spectral analysis using *code type inelastic spectrum* and its statistical distribution and *simplified code spectral inelastic capacity model* representation of the structure (obtained from static nonlinear analysis) in the presence of uncertainties.

The new method of analytical evaluation requires an experimental validation of the computational tool. Moreover, the definition of damage limit states in a structural system comprising many components (beams, columns, braces, joints, connections, etc.) requires quantification based on observed performance.

The availability of a large shaking table at the University at Buffalo made it possible to develop a series of models which can be tested and retested in various damage conditions. One 1:2 scale model, which was prepared and tested for evaluation of “toggle braces,” was also tested without any braces to provide data for the analytical verification of



■ Figure 1. Benchmark Frame for Study of Dampers

the computational tools. The model is a single story structure with story height of 6 feet 4 inches (approximately) and is shown in Figure 1. The horizontal span of the two identical frames for each direction is 8 feet 4 inches.

The gravity load applied is given by two concrete blocks with total weight of 32 kips. The detailing of connections and additional devices placed on the structure are given in the Appendix of Constantinou et al., 1997 or at http://civil.eng.buffalo.edu/users_ntwk/index.htm. The drawings show the plan view and elevations of the model, and detailing for connections and additional devices.

All MCEER researchers dealing with the analytical evaluation of fragility will use this research. The model will allow the testing of integration of innovative devices and systems in structures to improve their behavior for retrofit or repair. Moreover, since a benchmark model will be used, developers of computational tools will be able to calibrate their software based on common experimental evidence.

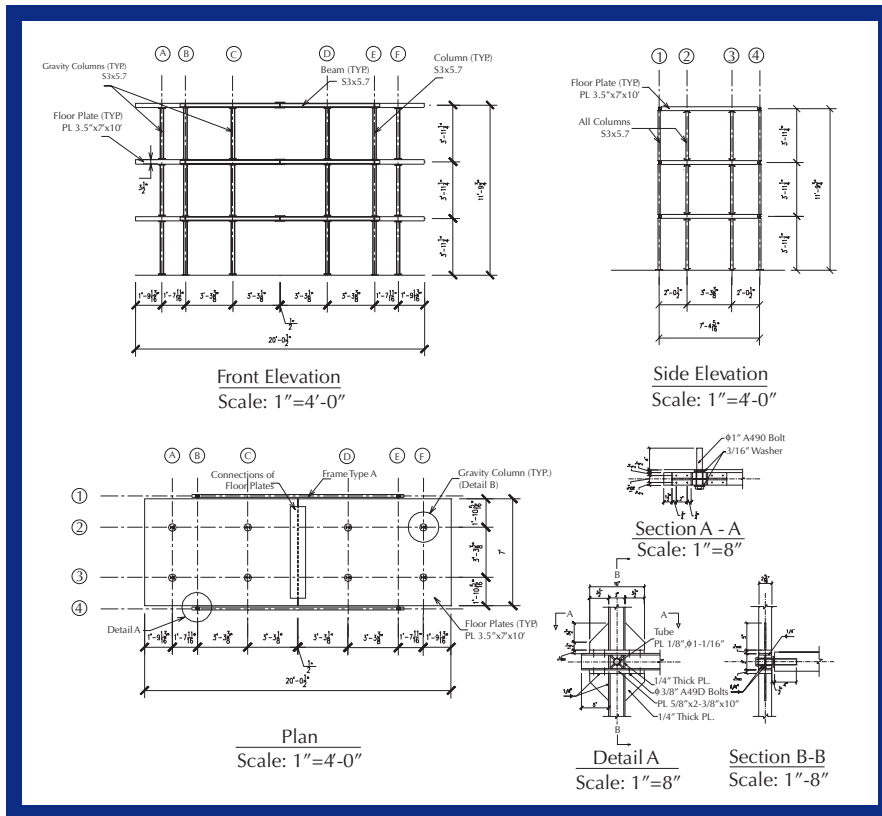

■ Figure 2. An Alternative Benchmark Model Design

The main benchmark 1:3 scale model was designed to have various configurations of the lateral loading system, while the floor masses will remain rigid and undamaged. The model is being prepared for construction.

Benchmark Model

The model was designed to be built with three to five stories using mass simulation and has removable components, which can be replaced by advanced components of new materials or functions. The design of the model was based on the following principles:

- Have a series of relevant sacrificial structural systems which can be “safely damaged” to collapse;
- Include a secondary system to carry gravity loads for control of stability;
- Use replaceable parts, which require minimum reinvestment;
- Produce damaged conditions at low levels of shaking, which fit the capability of the shaking table;
- Provide for accommodating new systems for retrofit or upgrading;
- Provide for incorporating new methodology of rocking columns;
- Provide for instrumenting and monitoring structural characteristics beyond the onset of damage;
- Allow the model to be reconfigured as an irregular structure for studies of torsion, impact (pounding) and 3D behavior;
- Design the model with detailed form materials and parts available in the industry.

For more information on MCEER's experimental/computational users network, see http://civil.eng.buffalo.edu/users_ntwk/index.htm.

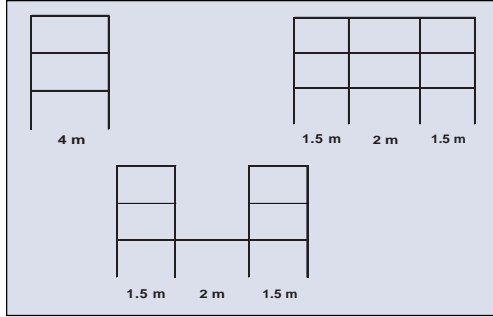

■ Figure 3. Alternative Designs for Side Frames (type a-c clockwise from top left)

Three alternative configurations (see Figure 3) were detailed and their construction is expected to be completed in the summer of 1999. Figure 2 shows one alternative design of the model.

The benchmark model was designed with gravity load carrying rocking columns, which are not damaged in a seismic event (see Figure 4). The separation of the vertical and lateral load carrying system will be studied as an alternative for new construction or retrofit. The system can be realized in full scale without incurring large costs.

The structure is designed with replaceable side frames or other lateral load carrying systems. The connections are such that the load is transferred into the joint and does not affect the other components. The system was designed to yield at low levels of excitation and to develop near ultimate lateral capacity.

The model was evaluated using a nonlinear time history analysis based on IDARC2D (Valles et al, 1996) and an approximation based on a nonlinear spectral capacity procedure (Reinhorn, 1997). The approximate evaluation consists of using the composite nonlinear response spectrum derived from the Elastic Design Spectra (DARS), S_s vs. S_{ap} to obtain the Inelastic Design Spectra (IDARS)

[Reinhorn, 1997 - based on Krawinkler and Nasser]

$$Sd^I = \frac{Sd^E}{R} \left[1 + \frac{1}{c} (R^c - 1) \right]$$

$$Sa^I = \frac{Sa^E}{R} \left[1 + \alpha \left(\frac{Sd^I}{u_y} - 1 \right) \right]$$

$$R = \frac{Sa^E W}{Q_y g} \quad u_y = \frac{Sd^E}{R}$$

$$c = \frac{T_0^a}{1 + T_0^a} + \frac{b}{T_0}$$

$$a = 1.0; \quad b = 0.37 \quad (\alpha = 2\%)$$

where the superscript E indicates elastic, versus I indicating inelastic, Q_y is the lateral yield resistance, W is the total weight and all other constants defined in the text or the relation. The spectral capacity is characteristic for any structure and was obtained from the actual base shear, BS , and the top floor displacement obtained from a nonlinear static procedure (IDARC2D) according to the following relations:

$$Q^* = \frac{BS}{\Gamma^2 g}; \quad u^* = \frac{u}{\Gamma \phi_1}$$

where Γ and ϕ are the modal characteristics of the dominant mode.

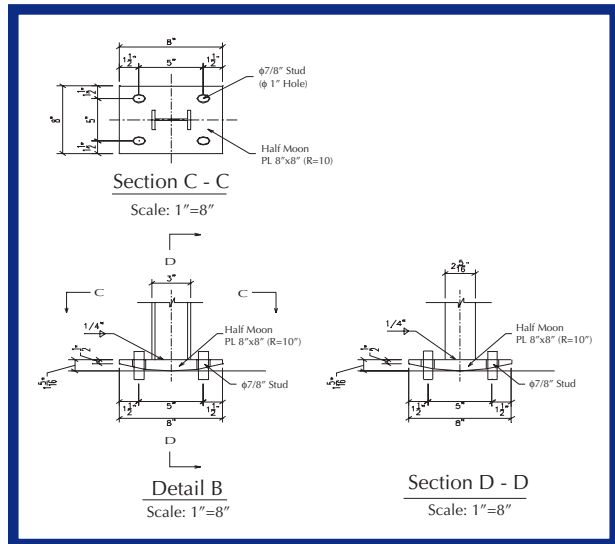

■ Figure 4. Details of Gravity Column

■ **Table 1.** Weight Sensitivity (Model 1 - 40 mtons, Model 2 - 53 mtons)

	T (sec)	R	μ	u^*/H (%)	Q^*
Model 1	1.41	2.75	2.63	5.4	0.18
Model 2	1.61	2.8	2.95	6.3	0.14

■ **Table 2.** Sensitivity to Structural Changes for Single Bay Frame

	T (sec)	R	μ	u^*/H (%)	Q^*
Model 1	1.41	1.65	1.62	3.3	0.16
Model 3	1.16	1.25	1.26	2.8	0.24

The spectral characteristics Q^* vs. u^* were then compared to the S_a vs. S_d demand to estimate the response (Reinhorn, 1997).

A sensitivity analysis was performed on the three types of models to obtain an optimal construction and generate sufficient observable damage. Table 1 shows the influence of changing the floor weight from 40 to 53 mtons, i.e. 30%.

The apparent response ductility, μ , changes by 10% when the weight increases by 30%. This is an inefficient way to increase inelastic response or for other designs to reduce the dynamic response.

The structural changes at the first floor using heavier steel shapes (S4 x 7.7 instead of S3 x 5.7) produce a reduction of 25% in the ductility (see Table 2). Although the strength increases substantially, the deformation reduces in smaller proportion.

The most sensitive parameter on the response and inelastic response is ground motion (see Table 3 and Figure 5) An increase in the ground motion produces almost proportional increases in

the inelastic deformation. The sensitivity analysis shows that with the maximum shaking table input, a global ductility of 3 is feasible. This ductility translates to larger local ductilities and spread plasticity effects.

The benchmark model was designed here with steel frames, however, construction details were prepared to allow concrete frames to be used in a symmetric or non-symmetric way. Moreover, the model was designed to allow for mass eccentricity to permit testing of torsional effects and triaxial interaction between individual components. Computational models are currently being developed (Simeonov et al., 1999) which will require experimental validation within the global system.

Most importantly, the benchmark model should be able to verify and validate the new spectral capacity approach and its adequacy

■ **Table 3.** Sensitivity to Input Ground Motion

PGA	R	μ	u^*/H (%)	Q^*
0.2	1.65	1.62	3.3	0.16
0.25	2	1.95	4	0.17
0.3	2.45	2.25	4.6	0.17
0.35	2.75	2.63	5.4	0.175
0.4	3.1	3	6.1	0.18

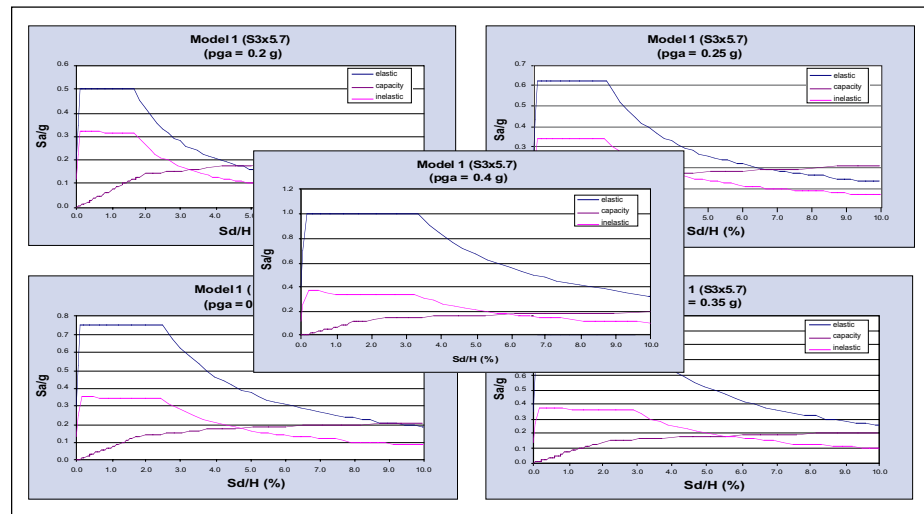

■ **Figure 5.** Spectral Response Evaluation of Model to Increasing Ground Motion

to new innovative protective systems, such as nonlinear dampers and active or semi-active systems. The model details will accommodate the addition of braces, removal of columns or other members, and so forth.

Conclusion and Future Research

The benchmark model (under construction) was also designed to reflect construction issues which are part of the MCEER hospital demonstration project. The model will be tested to determine the limit states associated with such construction and data interpretation will enable development of fragility information. The issues already identified are the irregularities in construction and distribution of floor weights, and the influence of nonstructural and architectural components. These can be simulated in the construction of the model for uncomplicated testing. The past experience of the authors

with reuse of structural models enabled them to design the model with the capability to accommodate modern protective systems, while still producing inelastic nonlinear behavior.

The model will first be tested to obtain simple elastic and then inelastic behavior to calibrate the analytical tools. The results will be made available via the web to the experimental/computational users network of MCEER (http://civil.eng.buffalo.edu/users_ntwk/index.htm - temporary address). The computational models will also be presented for further reference.

The immediate future plans for this project are to construct and instrument the model, including motion and force sensors, with multiple usage for immediate testing of several steel frames. One particular configuration, a candidate for the first round of testing, is the multiple towers building (see Figure 3(c)). Preparations are currently being made for this testing.

References

- Constantinou, M.C., Tsopelas, P. and Hammel, W., (1997), *Testing and Modeling of an Improved Damper Configuration for Stiff Structural Systems*, technical report submitted to the Center for Industrial Effectiveness and Taylor Devices, Buffalo, New York.
- Reinhorn, A.M., (1997), "Inelastic Analysis Techniques in Seismic Evaluations," *Seismic Design Methodologies for the Next Generation of Codes*, Krawinkler and Fajfar, eds., Proceedings of the Bled Slovenia Workshop, June 24-27, Balkema Publishers, pp. 277-287
- Simeonov, V.K., Sivaselvan, M. and Reinhorn, A.M., (1999), "State Space Approach in Nonlinear Analyses of Frame Structures," *Engineering Structures*, (Special Volume in honor of Professor Gear), (in review).
- Valles, R.E., Reinhorn, A.M., Kunnath, S.K., Li, C. and Madan, A., (1996), *IDARC2D Version 4.0: A Computer Program for the Inelastic Damage Analysis of Buildings*, Technical Report NCEER-96-0010, Multidisciplinary Center for Earthquake Engineering Research, Buffalo, New York.

Development of a Semi-Active Structural Control System

*by George C. Lee, Zhong Liang and Mai Tong,
University at Buffalo, State University of New York*

Research Objectives

This project seeks to develop a cost-effective semi-active control system for use in buildings and other structures to protect them from destructive earthquake ground motions. By applying a concept of physical parameter modification, the semi-active system is different from active control systems in that its operation does not require a large power source. Yet, the system is more effective in reducing structural response than traditional passive protective systems.

The fundamental research to develop the concept and control principles for the semi-active control system reported in this paper was funded by the National Science Foundation in 1993. Subsequently, the University at Buffalo provided seed money for the development of a small scale demonstration model that validated the principle. The current study is a continuation of the development towards commercialization funded through a Cooperative Agreement with the Office of Naval Research (ONR) as part of a DARPA (Defense Advanced Research Projects Agency), Technology Reinvestment Project (TRP) grant, intended to develop advanced technologies for both defense and civilian utilization. MCEER and the University at Buffalo are members of the ISMIS® Consortium, which includes Enidine Incorporated as the lead organization and Hydro-line, Inc. The Carderock Division, Naval Surface Warfare Center collaborates with the ISMIS Consortium through a CRADA, Creative Research and Development Agreement. The semi-active system under development is based on the idea of real-time structural parameter modification (RSPM) of the system.

The objectives are to develop and commercialize the RSPM technology (or semi-active control system), to improve the seismic performance of structures and to absorb shock in naval applications.

A number of passive structural vibration reduction technologies (earthquake protective systems) have already been used in structural engineering practice (e.g., base isolation systems and to a lesser extent, fluid dampers). The next frontier of implementing structural control technologies in practice is expected to be the semi-active type. These devices offer the advantages of an active control system but without requiring a large external power source for operation.

Sponsors

*MCEER/NSF
Office of Naval Research
through the Technology
Reinvestment Project of
the Defense Advanced
Research Project Agency
Enidine Incorporated
University at Buffalo, State
University of New York
National Science Foundation*

Collaborative Partners

*Enidine Incorporated
Hydro-line, Inc.
Carderock Division, Naval
Surface Warfare Center
Naval Research Laboratory*

Related MCEER Research Activities

- *Hospital Demonstration Project*
- *Rehabilitaion Strategies for Hospital Buildings and Contents, A.J. Aref, M. Bruneau, M.C. Constantinou, G.C. Lee, T.T. Soong, University at Buffalo, M.P. Singh, Virginia Polytechnic Institute, and S. Billington and M. Grigoriu, Cornell University*

This paper describes the recent progress of a special type of semi-active system (also known as a variable passive system) under development at MCEER. This project was initially funded by the National Science Foundation (NSF) through MCEER and the University at Buffalo for developing and proofing the concept. During the past two years, major progress has been made through the ONR/DARPA/TRP Project in partnership with the Carderock Division, Naval Surface Warfare Center, Naval Research Laboratory, Enidine Incorporated and Hydro-line, Inc. This project illustrates how results from a fundamental inquiry supported by NSF was further developed with major funding from mission agencies and industry for commercialization purposes. When fully developed, these devices will be used to protect critical facilities such as hospitals and their contents from damage due to earthquakes.

Introduction

It has always been a major challenge for the structural engineering profession, both in research and practice, to design and construct buildings and other structures to resist forces of nature. Fifty years ago, most engineers performed structural analysis and design based on principles of statics. For dynamic loading such as the forces generated by horizontal ground motions or wind gusts, a structure is designed with a stronger capacity (lateral stiffness) increase in the direction of the expected ground motions.

Since the late 1940s, basic principles of structural dynamics and plasticity theories have been developed, and pseudo-dynamic approaches (mostly based on single degree-of-freedom dynamic models) were introduced in earthquake engineering design. Special emphasis has been given to ductility requirements of structures in the lateral direction.

The current phase of study may be regarded as the development of enabling technology through a systems integrated approach. For defense applications, the product may be regarded as shock absorbers (an intelligent mechanical device) and the primary users would be designers and manufacturers of ships. For earthquake engineering, users would be planners, architects, structural engineers and contractors who are concerned with efficient and cost-effective methods to reduce the seismic responses of new and existing structures.

The immediate next step of the project is to implement a full-scale set of the system in a full-scale, real world structure and to develop specific design guidelines for the technology.

Architects and structural engineers who are challenged to design new structures or to retrofit existing structures to withstand seismic hazards have an increasing choice of devices to use. The supplemental energy dissipation device described in this paper offers another option to the designer.

In the last two decades, a new concept in earthquake engineering design has been advanced: performance-based engineering. At the same time, seismic vibration reduction technologies have been pursued by many researchers. This “structural control technology” is part of a widespread advancement in intelligent mechanical and material systems that are expected to improve the performance of structures in a cost-effective fashion.

Seismic response reduction technologies are typically classified into the following categories by earthquake engineering researchers:

- Passive Systems
 - Base isolation systems
 - Tuned-mass damper systems
 - Energy dissipation systems
- Active and Hybrid Systems
- Semi-Active (Variable Passive) Systems

To date, a number of passive systems have actually been implemented in buildings and other civil engineering structures. The most popular approach is to use a base isolation system. The tuned-mass damper approach has been used for wind vibration reduction in high-rise buildings, and various energy dissipation systems such as the bracing-type viscoelastic and viscous (fluid) dampers have been implemented in many buildings in recent years. MCEER researchers have been actively engaged in developing various passive and active control technologies since 1986. An MCEER monograph summarizing passive energy dissipation systems has recently been published (see Constantinou et al., 1998).

Most passive seismic protective systems are based on the general idea of increasing the damping of structures (Liang and Lee, 1991). To

do this properly, one must consider the structure together with the added device/system in the design process. This may not be a simple task, depending upon the type and configuration of the structure and type of base isolation/energy dissipation systems to be installed. Because ground motions are stochastic in nature and passive systems have only a limited range of effectiveness, active control systems are more efficient. However, except for protecting small or light weight objects, such as equipment, a major breakthrough on how to deliver large active counterforces is needed before widespread use can occur. Active control and hybrid control will remain at the research level with respect to their application to civil engineering structures for some time.

Semi-active systems include smart mechanical and material systems. Through switching or on-off actions, the physical parameters of a dynamic system can be modified in real-time. Because semi-active control systems use passive forces, the authors prefer to use the term variable passive control to contrast the active control that uses active forces. The most comprehensive variable passive system modifies all physical parameters simultaneously and is called real-time structural parameter modification (RSPM) (Lee et al., 1994).

Links to Current Research

- *Current efforts have gone beyond the fundamental research level and are in the midst of developing systems integrated enabling technologies by leveraging major funding from ONR through the Technology Reinvestment Project (TRP) of the Defense Advanced Research Project Agency (DARPA).*
- *The RSPM technology will be applied to the hospital project as an approach to increase the performance of the buildings and to protect the nonstructural components and equipment of the hospital to ensure its acceptable functionality during and after earthquakes.*

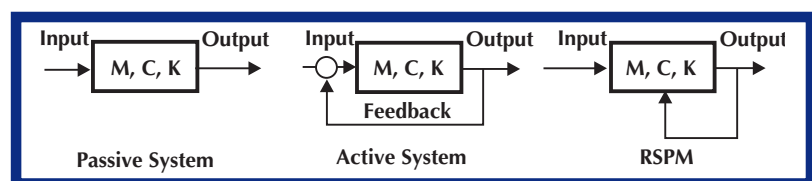

■ Figure 1. Comparison of Passive, Active and Semi-Active (RSPM) Systems

A simple conceptual comparison of the three types of earthquake protective systems is given in Figure 1. It is useful to note that the power

supply needed by active control devices is to develop counter forces, which consume the same type of mechanical energy as the external forces. For the RSPM (semi-active) system or any passive system, the power supply is not directly coupled with the mechanical energy of the structure.

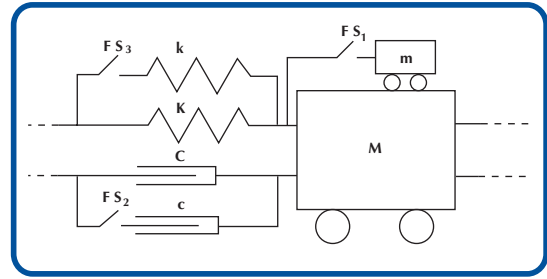

■ Figure 2. Energy Removal Mechanisms by Using Functional Switches (FS)

Variable Passive Control System

The system under development is referred to as real-time structural parameter modification (RSPM) technology. Although it is regarded as a semi-active system, it evolved from the traditionally defined active control system as an improvement (for not requiring large power supply). In the following discussion of research progress, the term RSPM control technology or ISMIS control technology will be used. ISMIS®, an abbreviation for Intelligent Shock Mitigation and Isolation System, is the registered trademark for Enidine Incorporated's commercial system for naval and civilian applications.

Conceptually, semi-active systems may involve variable damping and/or variable stiffness, as defined by Equations (1) and (2). The RSPM control system is described by Equation (3).

- Semi-Active Systems:

$$M\ddot{x} + C(t)\dot{x}' + Kx = F \quad (1)$$

variable damping, or

$$M\ddot{x} + Cx' + \underline{K}(t)x = F \quad (2)$$

variable stiffness

- RSPM:

$$\begin{aligned} & [M(t) + \Delta M]\ddot{x} + [C(t) + \Delta C]\dot{x}' \\ & + [\underline{K}(t) + \Delta \underline{K}]x = F \end{aligned} \quad (3)$$

The RSPM system basically consists of three components, the same as those of an active control system. They are: sensors, controllers and functional switches (actuators in the case of active control).

The functional switches are essentially hydraulic devices with the ability to deliver variable stiffness and/or variable damping. They are strategically located in a structure and individually controlled. Obviously, they can be connected/disconnected to mass and to base isolators.

Three typical utilizations of the functional switches are illustrated in Figure 2. In this figure, a functional switch is used to connect/disconnect an auxiliary mass m (FS_1), control an auxiliary damper (FS_2), and connect/disconnect auxiliary structural members to control the stiffness of the system (FS_3).

The MCEER project to develop RSPM technology began in 1993 when the basic concept was conceived and the first generation

■ Table 1. Development of the ISMIS® Technology

	1st Generation	2nd Generation	3rd Generation
Sensor	Accelerometers Velocity sensors	Accelerometers LVDT Loadcell	Loadcell Pressure sensor
Controller	Analog controller, Electro-magnetic solenoid valve	Digital controller, Servo valve	Analog controller, Electro-magnetic proportional valve
Functional Switch	Length = 6 in Weight = 4 lbs	Length = 38 in Weight = 210 lbs	Length = 38 in Weight = 70 lbs

Note: Length is determined by the application

■ Figure 3 shows the test set up for the first generation system and the corresponding functional switch.

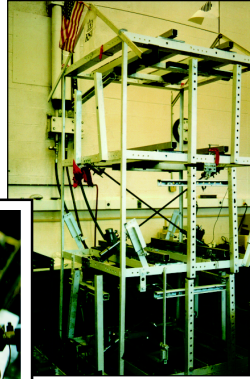
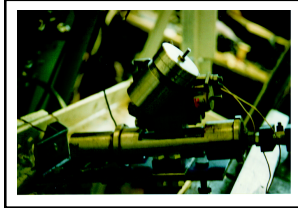

Development of Control Devices for RSPM Technology

The first generation system was a small prototype control device. It was a hydraulic device consisting of a plunger seated in a cylinder. An external fluid reservoir was connected to the internal chamber to back-fill it at

push-back stage. The reservoir prevents the cavity in the internal chamber, but is only maintained at atmosphere pressure. Thus, the device does not have any reserved stiffness from the pre-pressured fluid. The valve control is realized through an electro-magnetic solenoid. Detailed test data and performance of the device are reported in Liang et al. 1995; 1999.

The second generation of the control device was a servo-valve hydraulic system. The unit operates on high pressure hydraulic power. The device was built to realize high performance with the option to also examine other continuous type control schemes. The study of the control device is reported in Lee et al., 1998a; 1998b.

hardware system was manufactured. To date, experimental studies of the third generation system have been completed. This progression is illustrated in Table 1.

For the first generation system, the functional switch was approximately 6 inches long and weighed about four pounds (see Figure 3). That system provided a proof of the concept and a successful application for a U.S. patent (No. 5,526,609) to develop the technology. The second and third generation systems were developed under the ISMIS/TRP program sponsored by ONR and DARPA. The second generation system was developed and tested during 1996-97 (see Figure 4). This proof of concept functional switch used top of the line, commercial off the shelf components to provide the foundation for determining the best specifications for the next generation. These models weighed 200 lbs. The third generation system provided a more streamlined design, reducing the weight to 70 lbs, and was considered to be reasonably proportional to its length. This third generation system was manufactured and tested between 1997 and 1999. Results are summarized in a later section.

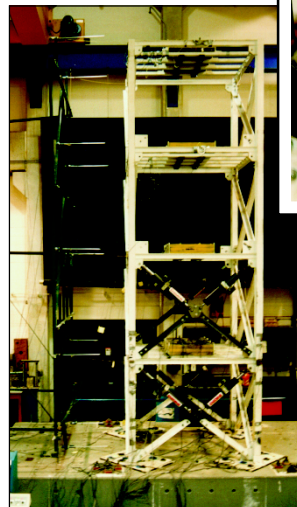

■ Figure 4 shows the test set up for the second generation system and the corresponding functional switch. The functional switch in this configuration was 38 inches long.

The third generation of the control device was a compact unit with all working parts built internally. The control valve was changed to an electro-magnetic proportional valve that operates on low voltage power. The electronic control circuit was simplified to further shorten the signal delay. Extensive tests of the device on a four story steel structure have been carried out.

Hierarchical Control System

The hierarchical control system is a special feature of the RSPM technology. Four levels of loops are included in the conceptual design. A detailed discussion of these hierarchical control loops can be found in Liang et al., 1995; 1999. The following is a brief summary of their logical connections.

The first level of the hierarchical control, L_1 , is a local loop. This loop was realized by employing simple and robust actuation. At present, a control algorithm for this level was created based on variation of stiffness parameters. It was found that the physical parameters under control do not need to be changed very frequently. This led to the development of a switching type of control device, which can tolerate more hostile environments. A local or global sensing system can be used to feed the control unit with the proper control signal. While the switching type of control bears the advantages of being simple, reliable and cost efficient, its limitation is that once the control command has been issued, it cannot reverse the effect. This problem is treated in the second loop.

The second level of the hierarchical control, L_2 , is also a local loop. It has been designed to deal with some major side effects associated with switching type of control. The typical scenarios are the signal delay and overdrift due to unbalanced force from a quick change of physical parameters. The delay issue involves many factors, which can become rather complicated. The overdrift often occurs at the time when response frequency is lower than the dominant natural frequency at the local area. This is primarily related to the phase differences between the input excitation and the local output response. Many algorithms have been studied to modify the primary control loop. Some detailed modeling on the signal delay is provided in Lee et al. 1998. Recent improvement of the technology has consisted of a combination of passive damping in the control devices to improve both side effects.

The third level of the hierarchical control, L_3 , is a global loop. When the control object is a complicated

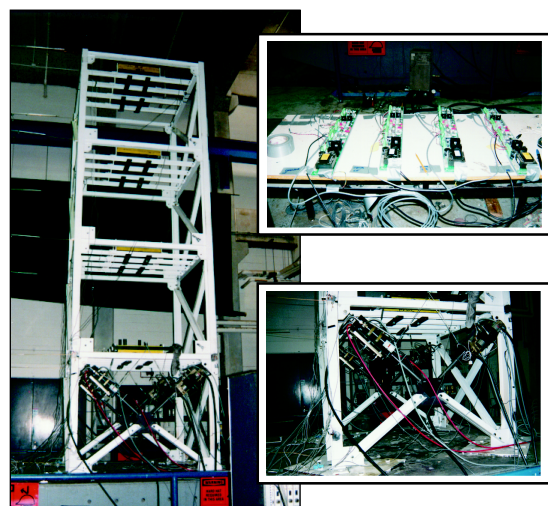

■ Figure 5. Test Setup for Third Generation System. The four story model is show at left; the top photo shows the control unit; the bottom photo provides a detailed view of the bracing type configuration.

structure, unevenly distributed dynamic characteristics may result in reductions of the overall performance of the control system. By employing a global optimization scheme, the performance may be improved. The global algorithm is still under development at present; the theoretical basis of the control algorithm is minimization of conservative energy (Constantinou et al., 1998, and Liang et al., 1995; 1999). The third level loop will override the first and second loops. However, the global loop control often requires a central processing unit, which adds cost to the entire system.

The fourth level of the hierarchical control, L_4 , is a safety loop. The control criteria are established by various safety concerns that are not directly related to the improvement of structural performance. Also, when the control units fails, the actuation device will set, by default, a fail-safe mode.

Experimental Observations

Testing has been an important part of the technology development from the initiation of the project. Back in 1994, a small model structure (see Figure 3) was used to test first generation control devices and verify the system concept (see Liang et al., 1995; 1999). Since 1997, tests have been performed on a new model using the acceleration controlled shaking table, which provides more accurate calibration of the technology.

Many technical specifications of RSPM technology are related to its design dynamic working range. Although the technology is robust and capable of covering a wide

dynamic working range, the cost of realizing the desired specification may vary significantly. For instance, the delay restriction for a 2 Hz application is much easier to solve than for 20 Hz. In order to test the RSPM technology for practical seismic applications, it was necessary to include some general structural characteristics in the test vehicle.

Since the majority of building structures requiring supplemental energy dissipation devices are high-rises, a four story moment resistant steel structure was designed for the shaking table tests. The structure is 6 feet (w) x 6 feet (l) x 20 feet (h) with a natural frequency of 2.0 Hz. The dead load is 50 lbs. per square foot, which is similar to that in a real structure.

The test structure was not intended to be a quarter scale structure in the strict sense. The consideration to abandon the usual similitude approach in the design was due to the following factors:

1. The test results of the technology are more relevant to practical application if the test dynamic working range is the same as the working range of full size devices.
2. The higher frequency problem is more demanding for the response time and often provides

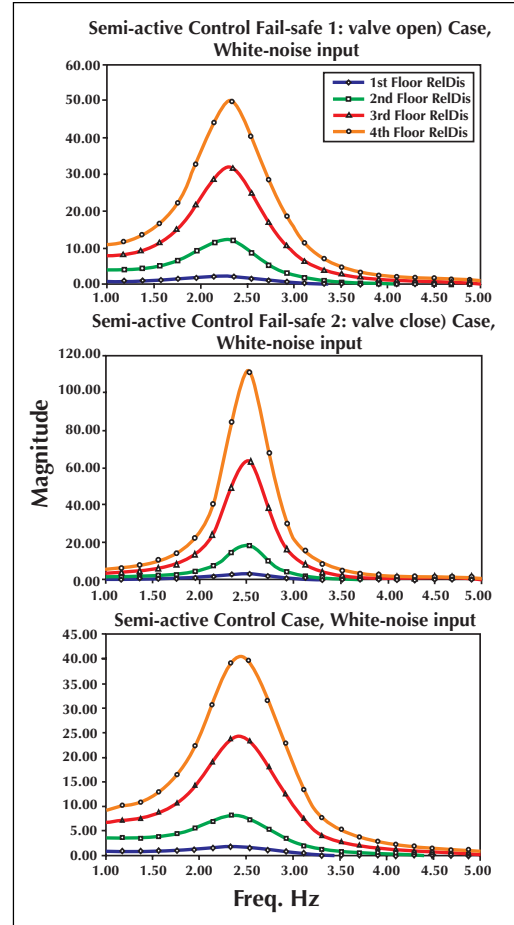

■ Figure 6. Floor Relative Displacement Frequency Response

■ Table 2. Kobe Earthquake Peak Response Comparison

Floor Disp.	(inch)	Frame	Passive Damping		High Stiffness		RSPM	
	1 st Floor	0.442	0.195	66.9%	0.158	73.2%	0.134	77.3%
2 nd Floor	0.997	0.428	67.8%	0.361	72.8%	0.303	77.2%	
3 rd Floor	1.419	0.608	67.9%	0.653	65.5%	0.515	72.8%	
4 th Floor	1.672	0.718	67.8%	0.859	61.5%	0.664	70.2%	

worse scenarios than lower frequency problems. Therefore, it was desirable to verify the technology at the higher frequency end.

3. The higher frequency prototype device and controller are more expensive.
4. Regular low-rise buildings are not considered to be good candidates for supplemental control devices for cost reasons.
5. Size limitations of the shaking table.

Although the test structure cannot provide all pertinent information about the technology, in particular, information concerning the multi-bay multi-story system, it has provided a basic understanding of the technology at its practical working range.

Test results obtained during 1998-99 are summarized below. The newest generation of the control device has the ability to switch between three states: damping, stiffness and ISMIS control. Each of the three states is compared under different input.

The test setup is illustrated in Figure 5, where the RSPM control devices are diagonally braced on the first and second floors of the four-story structure. Absolute displacement sensors were placed at each of the floors. Accelerometers and strain gages were placed on the floors and at connection areas, respectively.

Figure 6 shows the frequency response function of the three states with the third generation system. It was again verified that the switching scheme was effective when compared to high damping or high stiffness states. The corresponding damping ratios delivered by the three states were 13%, 8% and 14%, respectively.

Table 2 summarizes a set of displacement time history test results. Under 16% Kobe earthquake

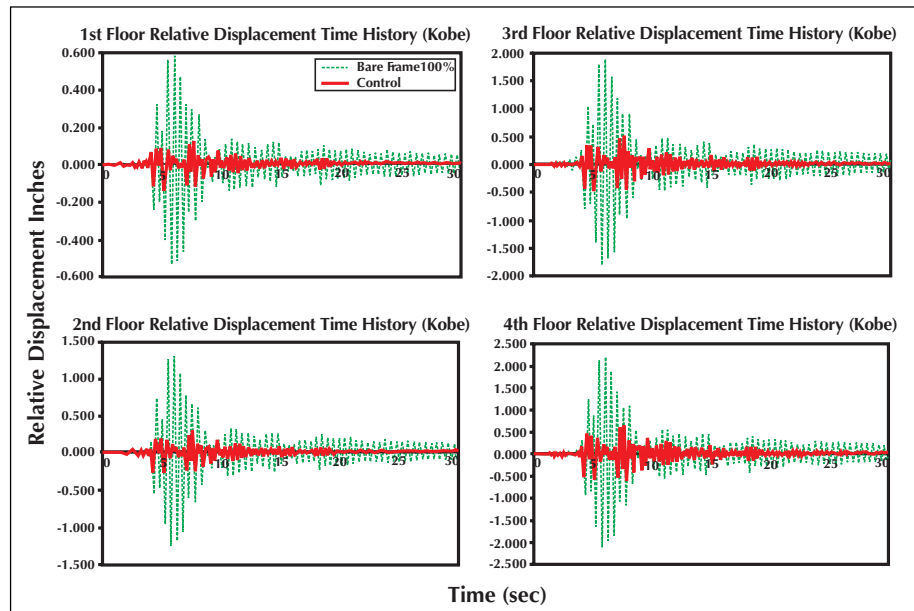

■ Figure 7. Relative Displacement Time History With and Without Control

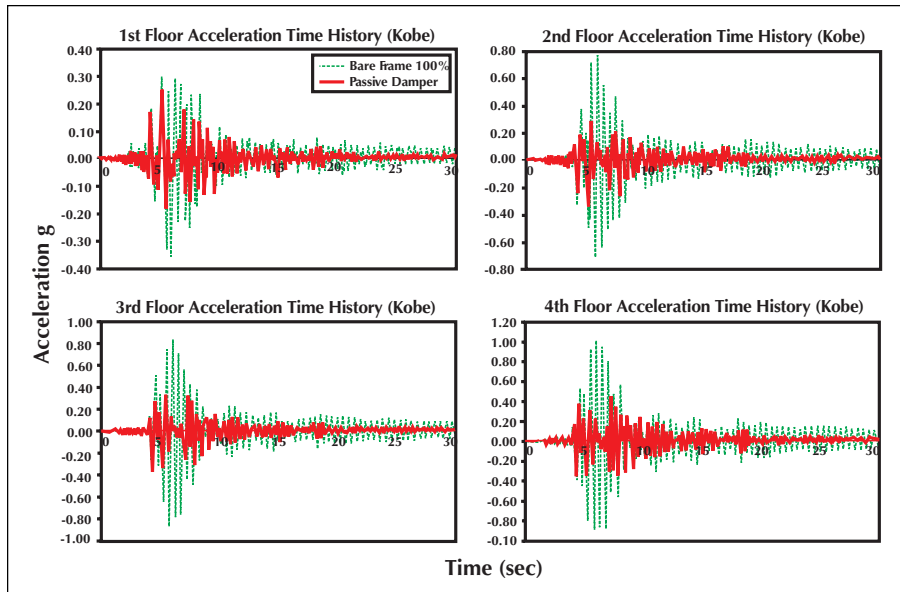

■ Figure 8. Acceleration Time History With and Without Control

excitation, the original responses of the structure were compared with passive damping, braced stiffness and RSPM control states.

Figure 7 provides the time histories of the displacement response with and without control. Figure 8 provides a comparison of acceleration response of the four floors. Based on a wide range of tests performed on the shaking table, which include white-noise, scaled earthquake records, and modified earthquake records, it was found that the RSPM technology is robust, and outperforms the two passive states in every test case. In particular, the reduction effect is more significant with the large amplitude real earthquake records.

Conclusion and Future Work

An extensive test program has established that ISMIS/RSPM can provide more effective control of story drift than many other passive energy dissipation devices. In particular, testing showed that RSPM

is potentially more cost effective than other devices, especially if combined with approaches such as structural bracing or base isolation (Ruan, 1997; and Ruan et al., 1997).

Currently, full scale implementation in a building is being reviewed. This will be one of the two major tasks for the project during 1999-2000. A second major task for 1999-2000 and beyond will be the continued development of guidelines for optimal (or new optimal) RSPM placement in a given structure. This is a rather complex problem but information is needed by the engineering profession dealing with structures (new or retrofit) to be implemented with all types of earthquake protective systems.

The RSPM technology can be applied to other energy dissipation and shock mitigation situations as a mechanical device, with minor modifications (see Lee et al., 1997, and Rasmussen et al., 1997). This is beyond the scope of earthquake engineering.

References

- Constantinou, M.C., Soong T.T. and Dargush, G.F., (1998), *Passive Energy Dissipation System for Structural Design and Retrofit*, Multidisciplinary Center for Earthquake Engineering Research Monograph Series, No. 1, 1998.
- Lee, G.C., Liang, Z. and Tong, M., (1994), "Innervated Structures," *Proceedings of the First World Conference on Structural Control*, Los Angeles, California, August.
- Lee, G.C., Tong, M., Liang, Z., Houston, B., Taylor, S., Clinard, L., Tomita, K. and Gottwald, W.D., (1997), "Structural Vibration Reduction with ISMIS Control Technology" *Proceedings of the 68th Shock and Vibration Symposium*, Baltimore, Maryland.
- Lee, G.C., Liang, Z., Tong, M., Niu, T., Song, J., Wu, Y., Qi, J. and Tomita, K., (1998a), "Seismic Test on a Model Structure with Variable Passive Control" *Proceedings of the 69th Shock and Vibration Symposium*.
- Lee, G.C., Liang, Z. and Tong, M., (1998b), "Development of a Variable Passive Control System for Structural Response Reduction" *Proceedings of the Second World Conference on Structural Control*, Kyoto, Japan.
- Liang, Z. and Lee, G.C., (1991), *Damping of Structures: Part I - Theory of Complex Damping*, Technical Report NCEER-91-0004, Multidisciplinary Center for Earthquake Engineering Research, Buffalo, New York.
- Liang, Z., Tong, M. and Lee, G.C., (1995), *Real-Time Structural Parameter Modification (RSPM): Development of Innervated Structures*, Technical Report NCEER-95-0012, Multidisciplinary Center for Earthquake Engineering Research, Buffalo, New York.
- Liang, Z., Tong, M. and Lee, G.C., (1999), "A Real-Time Parameter Modification (RSPM) Approach for Random Vibration Reduction. Part I: Principle and Part II: Experimental Verification," *Journal of Probabilistic Engineering Mechanics*, June.
- Rasmussen, F.F., Gottwald III, W.D., Krasnicki, E. and Lee, G.C., (1997), "Intelligent Shock Mitigation and Isolation system Through Applied Semi-Active Vibration Control Technology," *Proceedings of the 68th Shock and Vibration Symposium*, Baltimore, Maryland.
- Ruan, S., (1997), *Animated Control of Base Isolation Systems*, Ph.D. Dissertation, State University of New York at Buffalo.
- Ruan, S., Liang, Z. and Lee, G.C., (1997), "Animated Control of Base Isolation System," *Proceedings of the 15th International Model Analysis Conference*, Orlando, Florida.

GIS Characterization of the Los Angeles Water Supply, Earthquake Effects, and Pipeline Damage

by Thomas D. O'Rourke, Selcuk Toprak and Sang-Soo Jeon,
Cornell University

Research Objectives

The objectives of the research are to: 1) develop a comprehensive database of the size, composition, and geographic location of all Los Angeles Department of Water Power (LADWP) pipelines for system modeling and reliability analyses; 2) evaluate the spatial distribution of pipeline damage and its relationship with transient and permanent ground deformation parameters; and 3) use the resulting relationships to improve both loss estimation methodologies and the identification of seismic and geotechnical hazards in the Los Angeles area. There is a fourth objective that was also achieved, although its accomplishment was not foreseen at the start of the project, but emerged as a true scientific discovery as the work progressed. This fourth objective is to improve GIS characterization by defining an explicit relationship between the mesh size used to process point source geographic data and the two-dimensional visualization of these data through mapping algorithms.

MCEER-sponsored research focuses on improved loss estimation methodologies and the application of advanced technologies to improve water system performance. It is important therefore to evaluate how water systems respond to real earthquake conditions, using information technology for comprehensive characterization of the spatially variable pipeline network, transient and permanent ground deformation patterns, and geotechnical, groundwater, and topographical features. Geographical Information Systems (GIS) are ideally suited for this type of investigation, and were used to develop a detailed and extensive inventory of the Los Angeles Department of Water and Power (LADWP) water delivery system as well as a comprehensive assessment of system performance during the Northridge earthquake.

The 1994 Northridge earthquake resulted in the most extensive damage to a U.S. water supply system since the 1906 San Francisco earthquake. Los Angeles Department of Water and Power and Metropolitan Water District (MWD) trunk lines (nominal pipe diameter ≥ 600 mm) were damaged at 74 locations, and the LADWP distribution system required repairs at 1,013 locations. The widespread disruption provides a unique opportunity to evaluate

Sponsors

MCEER/NSF

Links to Current Research

- *This research project has identified the components and facilities that most seriously affect the earthquake performance of water systems and thus are prime targets for improvements using advanced technologies. This research is an integral part of the Lifelines Program, and is also an important contributor to the Emergency Response and Recovery Program through its in-depth characterization of critical water supplies and its development of advanced GIS applicable for post-earthquake damage assessment and deployment of emergency services and system restoration resources.*

Collaborative Partners

- *LADWP contributed extensive data sets, maps, and information about system facilities. The Department also contributed substantial amounts of engineering services to gather, evaluate, and verify the data and GIS work performed.*
- *Metropolitan Water District (MWD) of Southern California, California Department of Transportation (Caltrans), and Los Angeles Bureau of Engineering (LABE), all provided data and information pertaining to system characteristics, pre- and post-earthquake surveys, and Global Positioning System (GPS) control points.*
- *EQE International, Inc. and the California Office of Emergency Services provided the initial geocoded data about water supply system damage.*
- *The research work was coordinated with MCEER-supported studies of the LADWP electric power system supervised by M. Shinozuka, University of Southern California (USC), and with work supported by the Pacific Earthquake Engineering Research (PEER) Center on ground failures triggered by the Northridge earthquake, supervised by J.P. Bardet, USC.*

the geographic variability of the damage, the most vulnerable pipelines, and the relationship among damage, transient motion, and permanent ground deformation.

Cornell researchers collected information on nearly 1,100 water pipeline repairs after the Northridge earthquake, including location, pipe diameter, and composition of the lines. In addition, they digitized approximately 11,000 km of distribution mains (diameter < 600 mm) and 1000 km of trunk lines (diameter ≥ 600 mm) operated throughout the city of Los Angeles. This information was incorporated in a GIS using ARC/INFO software where it is combined with over 240 corrected strong motion records; vectors of horizontal displacement, heave, and settlement determined by air photogrammetry techniques; and Los Angeles street system, topography, surficial soils, and depths to water table.

Figure 1 shows that the portion of the Los Angeles water supply system

most seriously affected by the Northridge earthquake superimposed on the topography of Los Angeles. The water supply system includes transmission lines, trunk lines and distribution lines. All large diameter pipelines upstream of the treatment plants are considered to be transmission facilities.

Figure 2 presents charts showing the relative lengths of LADWP and MWD trunk and distribution lines, according to pipe composition. It should be noted that the vertical axis in Figure 2c is a logarithmic scale. The MWD trunk lines include pipelines within the area of the LADWP system designated by MWD as feeder lines. Total lengths of approximately 700 km and 300 km for LADWP and MWD trunk lines, respectively, are included in the database, and the pie charts in each figure show the relative percentages of the combined LADWP and MWD trunk lines associated with different types of pipe material.

The users of the research results include water utilities, such as the Los Angeles Department of Water and Power (LADWP), East Bay Municipal Utility District, Memphis Light, Gas and Water, and many other companies operating systems in areas vulnerable to earthquakes; governmental agencies, such as the Federal Emergency Management Agency (FEMA), which promote the development and application of earthquake loss estimation methodologies; and various private enterprises, such as electric power utilities, engineering firms, and insurance carriers, that are interested in advanced applications of GIS for civil infrastructure improvement and risk assessment. Research on advanced GIS technologies and risk assessment of lifeline networks not only provides for substantial improvements in seismic performance, but also establishes the platform for better management irrespective of seismic hazards. These improvements carry substantial societal benefits during normal operations through increased efficiency, safety and reliability, and through reduced maintenance and repair costs.

Collaborative Partners (cont.)

- Photogrammetric measurements with pre- and post-earthquake air photos were performed by the Hassbu Company through the supervision of **M. Hamada**, Waseda University, Tokyo, Japan.
- The evaluation of geotechnical and seismological characteristics of sites with concentrated lifeline damage was performed with input and cooperation with the U.S. Geological Survey, Menlo Park, California.

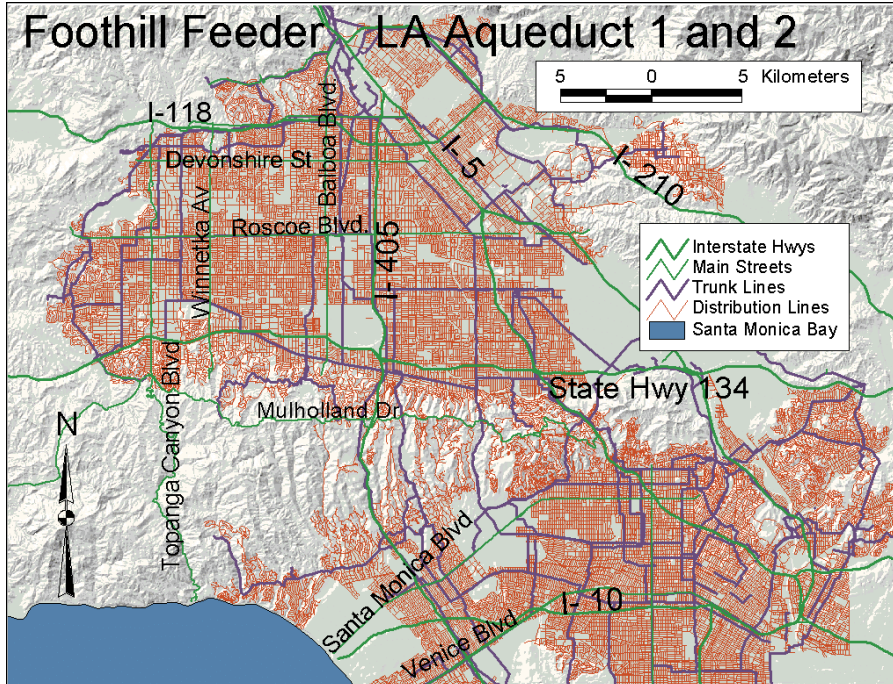

O'Rourke and Toprak, 1997

■ **Figure 1.** Map of Los Angeles Water Supply System Affected by the Northridge Earthquake

Figure 3 presents a map of distribution pipeline repair locations and repair rate contours for cast iron (CI) pipeline damage. The CI mains were shown to have the broadest geographic coverage, and therefore to provide the most consistent basis for evaluation of seismic response throughout the entire system (O'Rourke and Toprak, 1997). The repair rate contours were developed by dividing the map into 2 km x 2 km areas, determining the number of CI pipeline repairs in each area, and dividing the repairs by the distance of CI main in that area. Contours then were drawn from the spatial distribution of repair rates, each of which was centered on its tributary area. The 2 km x 2 km grid was found to provide a good representation of damage patterns for the map scale of the figure.

The records from approximately 240 rock and soil stations were used to evaluate the patterns of pipeline

damage with the spatial distribution of various seismic parameters. The maximum strong motion readings at the Tarzana-Cedar Hill Nursery were removed from the database prior to GIS evaluation to avoid distortions from possible topographic influences. In addition,

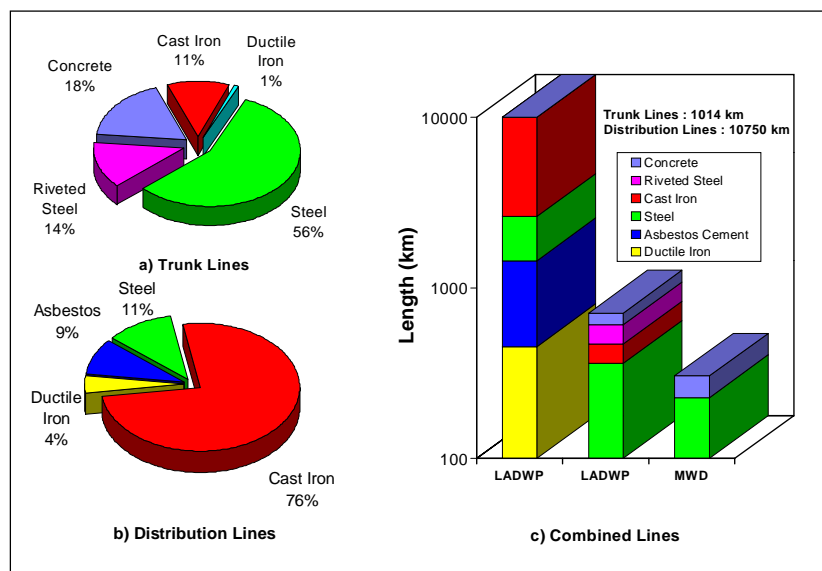

O'Rourke and Toprak, 1997

■ **Figure 2.** Composition Statistics of Water Trunk and Distribution Lines

Related MCEER Research Activities

- *Seismic Reliability Analysis and Retrofit Method for Southern California Power Systems*, **T.C. Cheng**, University of Southern California
- *Rehabilitation Strategies for Lifelines: LADWP Power Systems*, **S.T. Mau**, New Jersey Institute of Technology, **T.C. Cheng** and **M. Shinozuka**, University of Southern California

records from stations at dam abutments were screened when a station downstream of the dam was available, again to minimize distortion from topographic effects.

Figure 4 shows the CI pipeline repair rate contours superimposed on zones of peak ground velocity. By evaluating the zones of ground velocity with GIS, as illustrated in Figure 4,

it was possible to correlate the pipeline repair rates in all the zones characterized by a particular velocity with the velocity pertaining to those zones. As explained by O'Rourke (1998), similar evaluations were made of pipeline damage relative to spatially distributed peak acceleration, spectral acceleration and velocity, Arias Intensity, Modified Mercalli Intensity (MMI), and others indices of seismic

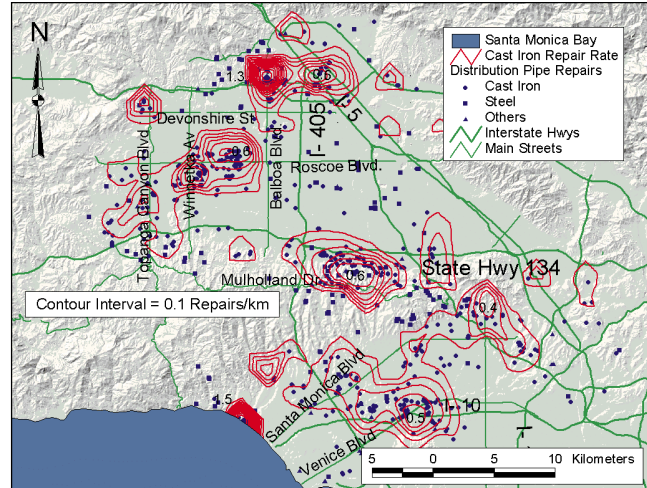

O'Rourke and Toprak, 1997

■ Figure 3. Cast Iron Pipeline Repair Rate Contours for the Northridge Earthquake

response. By correlating damage with various seismic parameters, regressions were developed between repair rate and measures of seismic intensity.

The most statistically significant correlations for both distribution and trunk line repair rates were found for peak ground velocity. Figure 5a presents the linear regression that was developed between CI pipeline repair rates and peak ground velocity on the basis of data from the Northridge and other U.S. earthquakes. Figures 5b and 5c show repair rate correlations for welded steel trunk lines and for cast iron, ductile iron, and asbestos cement distribution lines. Figure 5d compares the regressions developed in this research work with the default relationship used in HAZUS (NIBS, 1997), which is the computer program that implements the current earthquake loss estimation methodology sponsored by FEMA. The FEMA correlation does not distinguish between trunk or distribution lines, nor does it allow for predictions based on pipe composition. The data pertaining to the FEMA

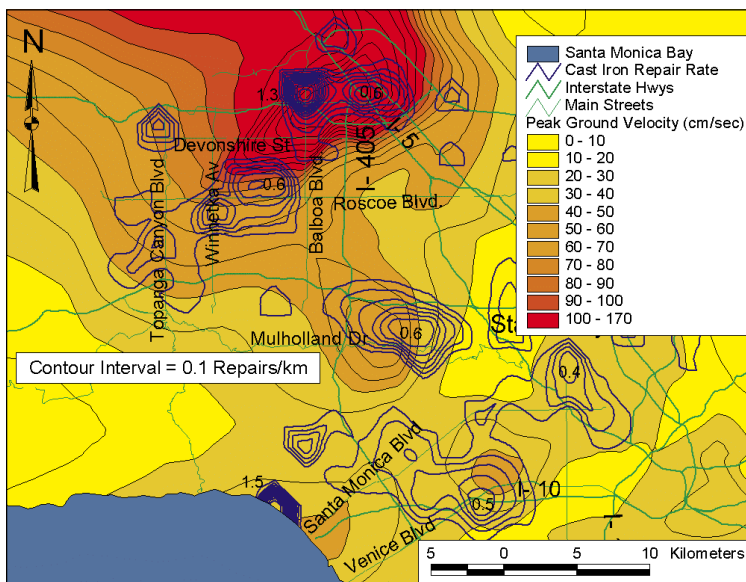

O'Rourke and Toprak, 1997

■ Figure 4. Pipeline Repair Rate Contours Relative to Northridge Earthquake Peak Ground Velocity

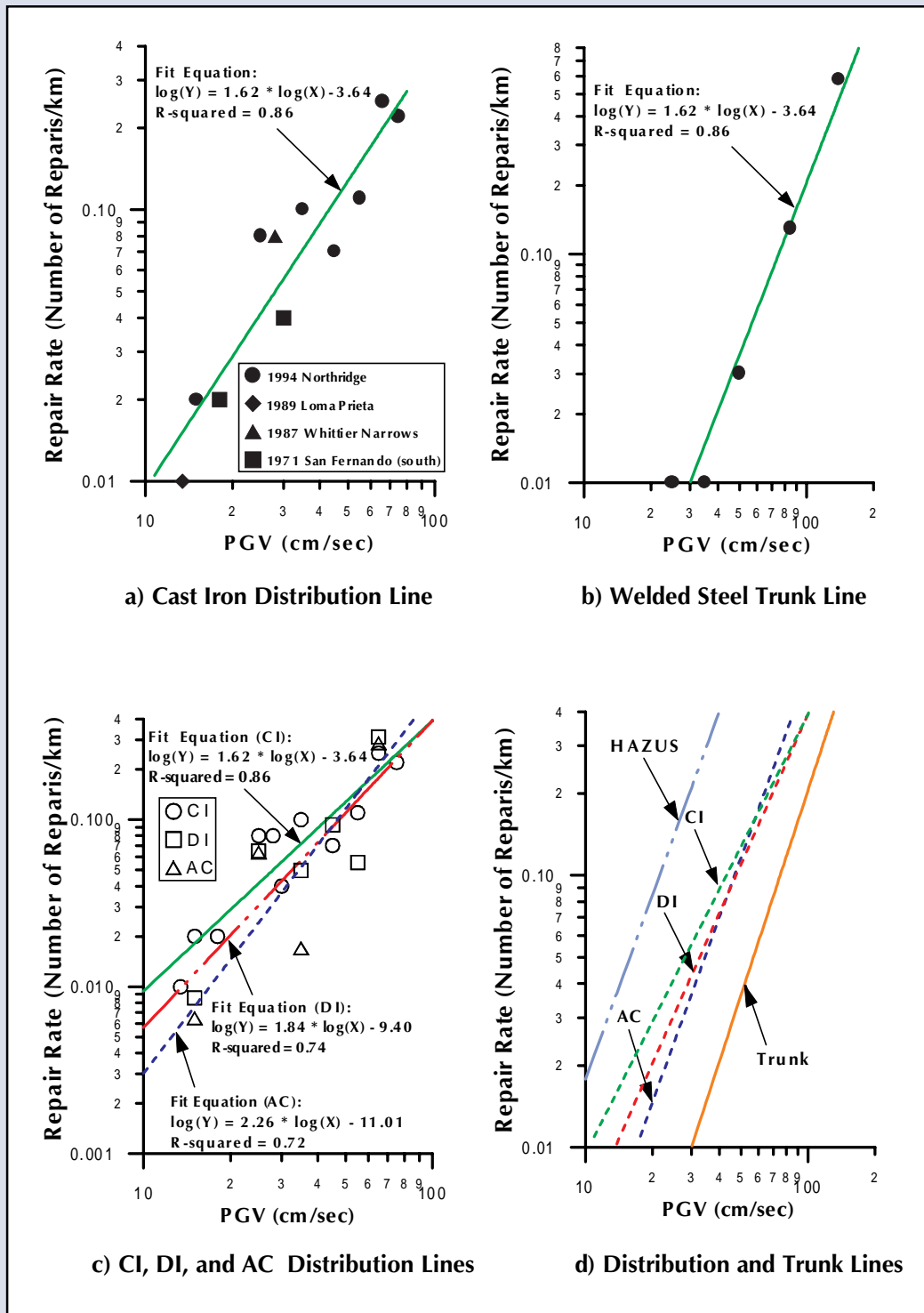

■ Figure 5. Pipeline Repair Rate Correlation with PGV for CI, DI and AC Distribution and Welded Steel Trunk Lines

correlation were analyzed before the current generation of GIS technologies, and are strongly influenced by repair statistics for the Mexico City water supply after the 1985 Michoacan earthquake (Ayala and O'Rourke, 1989). Inspection of Figure 5d reveals that the current default relationship in HAZUS is very conservative, and results in predicted repair rates that exceed those provided by the regressions developed in the MCEER-sponsored research by over an order of magnitude for steel trunk lines and by a factor of two to three for distribution mains subjected to velocities greater than 20 cm/s.

After the Northridge earthquake, pre- and post-earthquake air photo measurements in the Van Norman

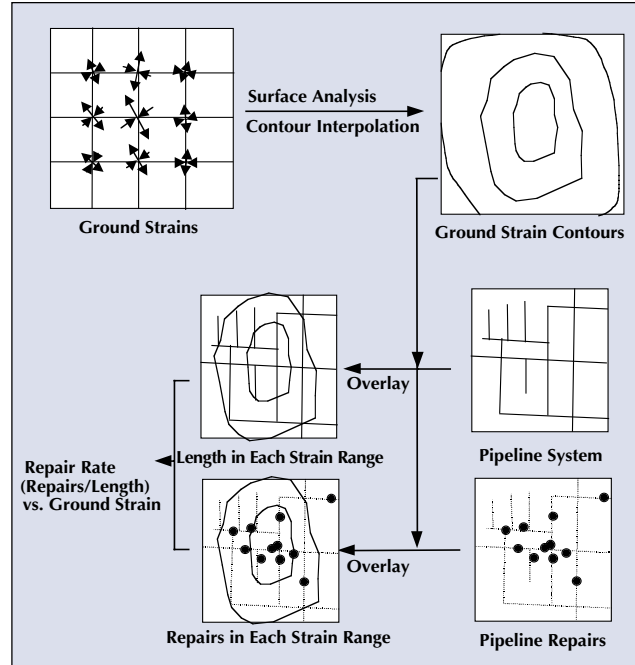

O'Rourke et al., 1998

■ Figure 6. Procedure for Calculating Repair Rate in Each Strain Range

Complex were analyzed as part of collaborative research between U.S. and Japanese engineers (Sano, 1998; O'Rourke et al., 1998). The area near the intersection of Balboa Blvd. and Rinaldi St. has been identified as a location of liquefaction (Holzer et al., 1996) where significant damage to gas transmission and water trunk lines was incurred. Ground strains were calculated in this area from the air photo measurements of horizontal displacement by superimposing regularly spaced grids with GIS software onto the maps of horizontal displacement and calculating the mean displacement for each grid. Grid dimensions of 100 m x 100 m were found to provide the best results (Sano, 1998).

As illustrated in Figure 6, ground strain contours, pipeline network, and repair locations were combined using GIS, after which repair rates corresponding to the areas delineated by a particular contour

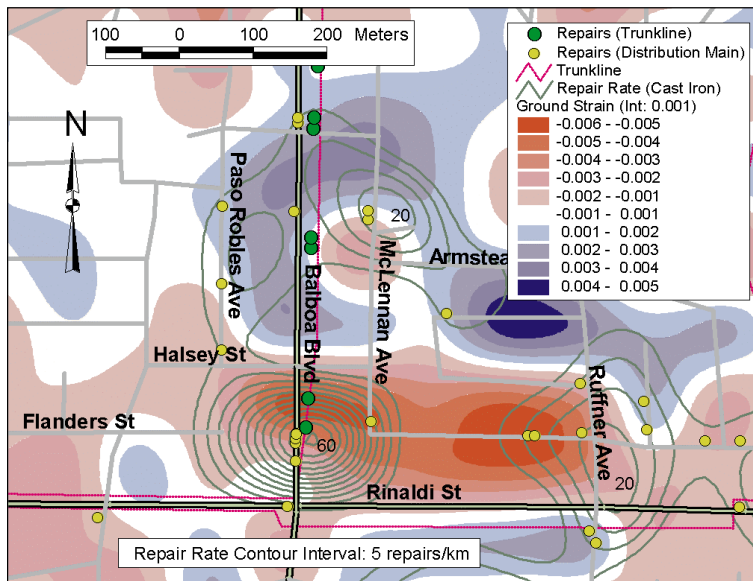

O'Rourke et al., 1998

■ Figure 7. Distributions of CI Repair Rate and Ground Strain

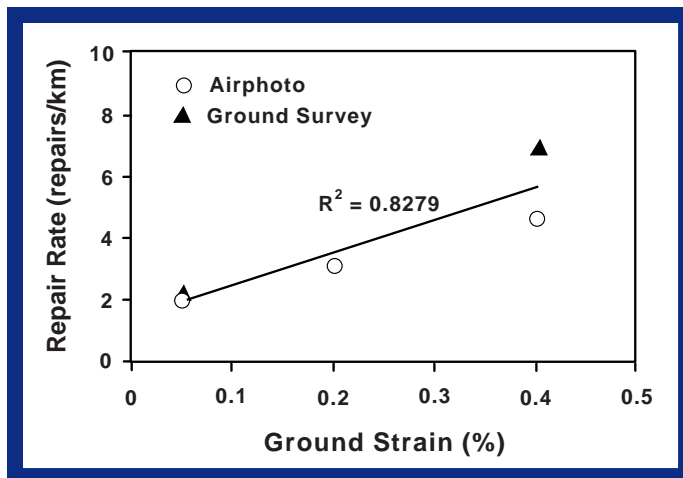

O'Rourke et al., 1998

■ Figure 8. Correlation between Ground Strain and CI Repair Rate

interval were calculated. Figure 7 shows the repair rate contours for CI mains superimposed on the areal distribution of ground strains, identified by various shades and tones. In the study area, there were 34 repairs to CI water distribution mains and two for steel water distribution pipelines. There were five water trunk line repairs in the area. The repair rate contours were developed by dividing the map into 100 m x 100 m cells, determining the number of CI pipeline repairs in each cell, and dividing the repairs by the length of the distribution mains in that cell. The intervals of strain and repair rate contours are 0.001 (0.1%) and 5 repairs/km, respectively. The zones of high tensile and compressive strains coincide well with the locations of high repair rate.

In Figure 8, the relationship between ground strains and repair rates is presented graphically using linear regression. The repair rate in each ground strain range, 0-0.1, 0.1-0.3, and 0.3-0.5%, was calculated as explained previously. Ground strain contours obtained both from the air photo measurements and LBE survey were used. As shown in this

figure, repair rates increase linearly with ground strain. A high r^2 value shows that a large percentage of the data variability can be explained by the regression line.

With GIS, it is very easy to divide a spatially distributed data set into arbitrarily sized areas.

If the areas are delineated by a framework of equally spaced, vertical and horizontal lines, the resulting grid can be characterized by a single dimension representing one side of each area, n , and the number, N , of areas comprising the total area of the system, Nn^2 . The choice of n can be regarded as a means of visually resolving the distribution of damage.

Some practical questions emerge. Is there a useful relationship between n and the visualization of zones with high damage? An additional question may be asked about what values of n represent the best choices for visualizing damage patterns?

In this research project, a relationship was discovered between the area of the map covered by repair rate contours and the grid size, n , used to analyze the repair statistics. If the contour interval is chosen as the average repair rate for the entire system or portion of the system covered by the map, then the area in the contours represents the zones of highest (greater than average) earthquake intensity as reflected in pipeline damage. The area within the contour lines

“The GIS-based research focused on the LADWP system has resulted in the largest U.S. database ever assembled of spatially distributed transient and permanent ground deformation.”

divided by an area closely related to the total area of the map, A_c , is referred to as the threshold area coverage, TAC (Toprak et al., 1999). Alternate thresholds may also be defined on the basis of the mean plus one or two standard deviations.

A hyperbolic relationship was shown to exist between TAC and the dimensionless grid size, defined as the square root of n^2 , the area of an individual cell, divided by the total map area, A_T . This relationship is illustrated in Figure 9, for which a schematic of the parameters is provided by the inset diagram. The relationship was found to be valid over a wide range of different map scales spanning 1200 km² for the entire Los Angeles water distribution system affected by the Northridge earthquake to 1 km² of the San Francisco water distribution system in the Marina affected by the Loma Prieta earthquake (Toprak et al., 1999). The data points refer to maps

of various dimensions from which the relationship was developed.

This relationship can aid GIS users to get sufficiently refined, but easily visualized, maps of damage patterns. Because the relationship is independent of size and will work at the scale of the entire system or any practical subset thereof, it can be used for damage pattern recognition, and for computer “zooming” from the largest to smallest scales to identify zones of concentrated disruption. This relationship has great potential for data management to support emergency response decisions and planning for optimal post-earthquake recovery.

Conclusions

The GIS-based research focused on the LADWP system has resulted in the largest U.S. database ever assembled of spatially distributed

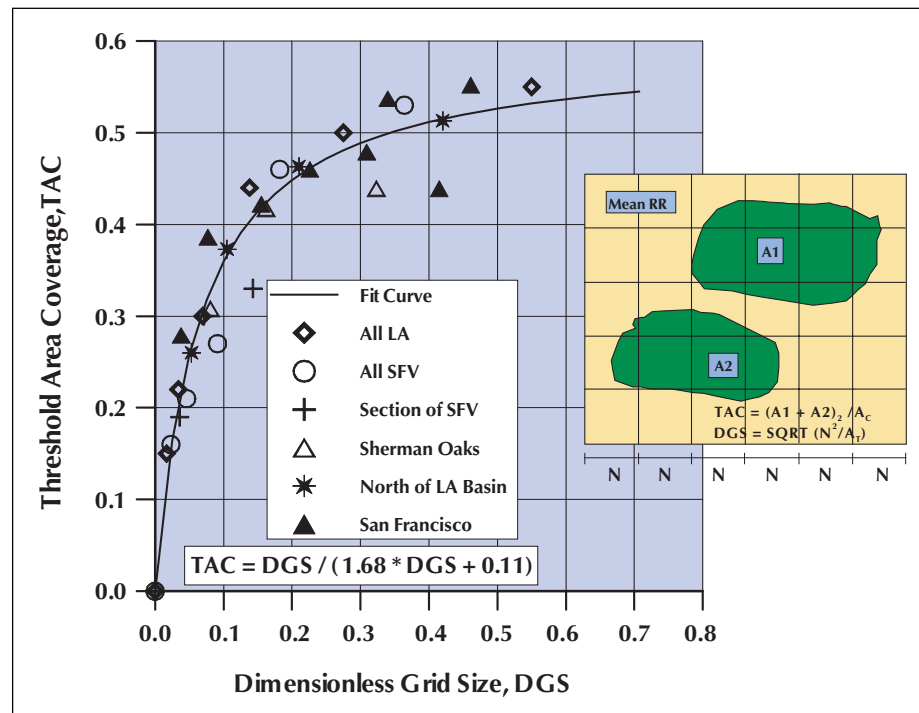

Toprak et al., 1999

■ Figure 9. Hyperbolic Fit for Threshold Area Coverage and Dimensionless Grid Size

transient and permanent ground deformation in conjunction with earthquake damage to water supply and other lifeline systems. The research has led to a better delineation of local geotechnical and seismological hazards that are shown by the zones of concentrated pipeline damage after the Northridge earthquake. The research has resulted in correlations between repair rates for a variety of trunk and distribution pipelines and seismic parameters, such as peak ground velocity. These correlations are statistically reliable and have improved predictive capabilities compared with the default relationships currently used in computer programs developed by FEMA for earthquake loss estimation. The research has led to the discovery of a relationship between the two dimensional representation of local damage and the grid size used in GIS to analyze the spatial distribution of data. For practical purposes, this relationship is independent of scale and therefore ideally suited for damage pattern recognition and computer “zooming” from largest to smallest scale to target areas for emergency response and recovery.

The research has resulted in a comprehensive GIS characterization of the LADWP pipeline network, earthquake damage patterns, and spatial distributions of seismic

parameters, permanent ground deformation, geotechnical hazards, topography, and groundwater tables. This characterization will be used in forthcoming systems analysis and reliability assessments of the LADWP water supply network. Because of its unprecedented size, complexity, and accuracy, this GIS data set is currently being used in studies at the NSF-supported Institute for Civil Infrastructure Systems to explore relationships between physical infrastructure systems and the social, economic, and political databases that coincide with them.

An evaluation of the earthquake damage statistics of the LADWP system has disclosed critical components that are most susceptible to earthquake damage and have the greatest impact on system performance. Based on the findings of this work, future research will focus on the welded slip joints of steel trunk lines that are susceptible to compressive failure under transient and permanent ground deformation. Research will concentrate on characterizing the load-deformation behavior of these joints and the use of externally applied fiber reinforced composites (FRCs) to increase their load carrying capacity as part of either retrofit or new construction activities.

References

- Ayala, A.G., and O'Rourke, M.J., (1989), *Effects of the 1985 Michoacan Earthquake on Water Systems in Mexico*, Technical Report NCEER-89-0009, Multidisciplinary Center for Earthquake Engineering Research, Buffalo, New York.
- Holzer, T.L., Bennett, M.J., Tinsley III, J.C., Ponti, D.J., and Sharp, R.V., (1996), “Causes of Ground Failure in Alluvium during the Northridge, California, Earthquake of January 17, 1994,” *Proceedings from the Sixth Japan-U.S. Workshop on Earthquake Resistant Design of Lifeline Facilities and Countermeasures Against Soil Liquefaction*, Waseda University, Tokyo, Japan, June 11-13, 1996, Technical Report NCEER-96-0012, Multidisciplinary Center for Earthquake Engineering Research, Buffalo, New York, pp. 345-360.

- National Institute of Building Sciences, (1997), *Earthquake Loss Estimation Methodology: HAZUS*, NIBS Document No. 5201 prepared for Federal Emergency Management Agency, Technical Manual Vol. 1 and 2, Washington, D.C.
- O'Rourke, T.D., (1998), "Overview of Geotechnical and Lifeline Earthquake Engineering," *Geotechnical Special Publication No. 75*, ASCE, Vol. II, P. Pakoulis, M. Yegian, and D. Holtz, Eds, Reston, Virginia, pp. 1392-1426.
- O'Rourke, T.D. and Toprak, S., (1997), "GIS Assessment of Water Supply Damage Caused by the Northridge Earthquake", *Proceedings of the Sixth U.S. National Conference on Earthquake Engineering*, Seattle, Washington, EERI, May.
- O'Rourke, T.D., Toprak, S. and Sano, Y., (1998), "Factors Affecting Water Supply Damage Caused by the Northridge Earthquake," *Proceedings of the Sixth U.S. National Conference on Earthquake Engineering*, Seattle, Washington, June, pp. 1-12.
- Sano, Y., (1998), *GIS Evaluation of Northridge Earthquake Ground Deformation and Water Supply Damage*, M.S. Thesis, Cornell University, Ithaca, New York.
- Toprak, S., O'Rourke, T.D., and Tutuncu, I., (1999), "GIS Characterization of Spatially Distributed Lifeline Damage," *Proceedings of the Fifth U.S. Conference on Lifeline Earthquake Engineering*, Seattle, Washington, August, in press.

Axial Behavior Characteristics of Pipe Joints Under Static Loading

by Emmanuel Maragakis, Raj Siddharthan and Ronald Meis,
University of Nevada - Reno

Research Objectives

The objective of this study is to perform physical testing on pipe joint segments to determine the axial static load behavior characteristics of various types of pipe joints typically used in both above ground and buried piping systems. The pipe joints considered include cast iron, steel, and ductile iron bell and spigot joints as well as newer types of restrained joints, and other types of pipe materials such as PVC and polyethylene. This effort is part of an overall research project to determine the dynamic behavior characteristics of pipe joints and to develop fragility information and risk assessment data.

Damage reports from past earthquakes have clearly revealed that buried and above surface pipelines are prone to severe damage in areas of strong shaking. Given the vital importance of this infrastructure system, understanding how pipe and pipe joints respond during an earthquake is a necessity. The proposed testing is the first phase of an overall research project designed to determine the static and dynamic strength characteristics of pipe joints, and to develop fragility information and risk assessment data. Such information is critical to determine potential damage of piping systems when subjected to seismic motion. Among the many well-documented pipeline failures under earthquake loading, a few important studies have been selected and summarized below.

O'Rourke (1996) reviewed the performance of and damage to pipelines following various earthquakes. In the 1989 Loma Prieta earthquake, the major damage was concentrated in areas of liquefaction such as the Marina district in San Francisco. San Francisco, Oakland, Berkeley, and the Santa Cruz area had almost 600 water pipeline failures. In the 1994 Northridge earthquake, over 1,400 failures were reported including 100 failures to critical large diameter pipelines. In the 1995 Kobe earthquake, as many as 1,610 failures occurred in distribution water mains and 5,190 failures occurred in distribution gas mains.

Sponsors

MCEER/NSF

Links to Current Research

- *The results of this research are one of the critical inputs to the seismic vulnerability assessment of piping systems. Such vulnerability studies are necessary to undertake cost effective retrofit measures based on engineering information.*

Collaborative Partners

- *Pipe manufacturers, including U.S. Pipe, ACIPCO, EBBA Iron, and Uni-Flange, donated in all more than 15 pipe joint segments and appropriate end flanges, shipping costs and samples of joint restraint mechanisms.*
- *Manufacturer's associations, including the Ductile Iron Pipe Research Association (DIPRA) and the American Water Works Association (AWWA), provided technical and other research materials and contact names.*
- *Several pipeline owners, including East Bay Municipal Utility District (Oakland-Berkeley area), Pacific Gas and Electric Company (Central and Northern California), Sierra Pacific Power Co. (Northern Nevada area), and Los Angeles Dept. of Water and Power (Los Angeles Area), have provided valuable input and encouragement to this project.*
- *Western Nevada Supply Co. and Intermountain Piping Systems have provided items such as pipe segments for testing, mechanical bolted joint restraints, and other miscellaneous supplies.*

Trifunac and Todorovska (1997) reported on a detailed investigation of the amount of pipe breaks that occurred in the Northridge earthquake. They concluded that the “pipe breaks correlate well with the recorded amplitudes of strong ground motion....”. They presented empirical equations which related the average number of water pipe breaks per km of pipe length with the peak strain in the soil or intensity of shaking at the site.

O’Rourke and Palmer (1996) reviewed the historical performance of gas pipelines, steel and plastic, in southern California over a 61 year period. Statistics are provided for 11 major earthquakes starting from the 1933 Long Beach earthquake up to the 1994 Northridge earthquake.

Iwamatu et al. (1998) and Kitaura and Miyajima (1996) documented failures and the failure rate (per km) in the 1995 Kobe earthquake. These researchers provided a comprehensive summary of pipeline damage in terms of pipe material type, joint types, and the failure

mechanisms that were observed. They reported that the majority of pipeline failures were at the joints, and the predominate modes of failure were slip-out of the joints and the intrusion of the spigot into the bell. For this reason, the emphasis of this testing is on axial loading behavior (compression and tension).

A thorough survey of the literature reveals that laboratory tests on pipe joints are limited. Singhal (1984) performed a number of static experiments on bell and spigot rubber gasketed joints to determine their strength and stiffness characteristics. The joints were subjected to axial and bending loading. In some tests, the joints were encased in a “sand box” that allowed the soil-pipe interaction and overburden pressures to be included. The author provided failure criteria in terms of deformations for various sizes of pipes. Wang and Li (1994) conducted studies on the damping and stiffness characteristics of conventional ductile iron pipe joints subjected to dynamic cyclic loading.

The documentation and results of this project will be useful to several different groups. Other researchers involved with physical testing of pipelines will be able to benefit from the methodologies and procedures that have been developed and used for this project. Manufacturers of pipe and joint restraint systems will have information on the behavior characteristics of their product. It will also benefit those who intend to consider using polyethylene pipe to replace conventional pipe material normally used for water supply. The project results will enable pipeline designers and manufacturers to effectively quantify the merits of relatively new products such as pipeline joint restraints and polyethylene pipe. Furthermore, pipeline owners can use fragility information and risk assessment data developed by this project to determine regions within their service area that may be vulnerable to damage from earthquakes. This will help them with upgrade and retrofitting plans of their piping systems.

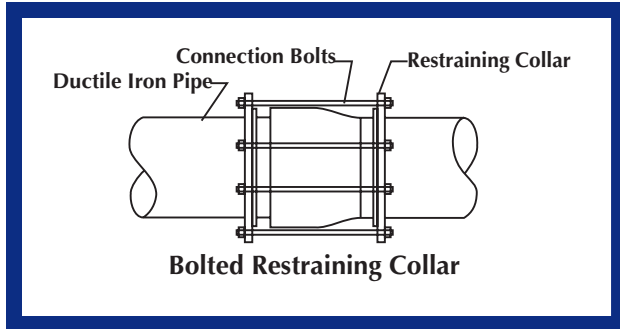

■ Figure 1. Bolted Restraining Collar

This paper presents the initial pipe joint test results for a variety of pipe materials including ductile iron, welded steel, cast iron, PVC, and polyethylene. For ductile iron pipe, two different joint restraints were tested:

- reinforced gasket
- bolted restrained collars.

Figure 1 shows a sketch of a ductile iron pipe provided with bolted collar restraints. Details on the testing, configuration, loading procedures, and test results are described with accompanying plots and graphs.

Overview of Testing

The testing procedure used for this project consisted of developing a method of applying an axial load (compression and/or tension) to a pipe joint and recording the pipe barrel strains and the load-displacement relationship. Initially, a series of compressive loading tests (Phase I) were conducted on ductile iron pipe joint specimens in order to establish the range of axial load capacity for various diameters of pipe. This test series was conducted using a SATEC compression testing machine. The second phase (Phase II) of this testing

consisted of applying compression and/or tension loading to pipe joint segments using a self-contained loading frame that was designed and constructed specifically for this testing. More details on this phase of the testing are presented subsequently.

Preliminary Compressive Testing on Ductile Iron Pipe Joints (Phase I)

In this testing phase, the ends of the ductile iron bell and spigot pipe joint segments of different diameters were milled to achieve smooth end surfaces. The specimens were placed in our SATEC compression testing machine and loaded until noticeable fracture occurred. The pipe sizes tested were 4", 6", 8", and 10" diameter. The load-displacement values were electronically recorded and stored using a Megadac data acquisition system. The results of the testing are shown in Figure 2. It can

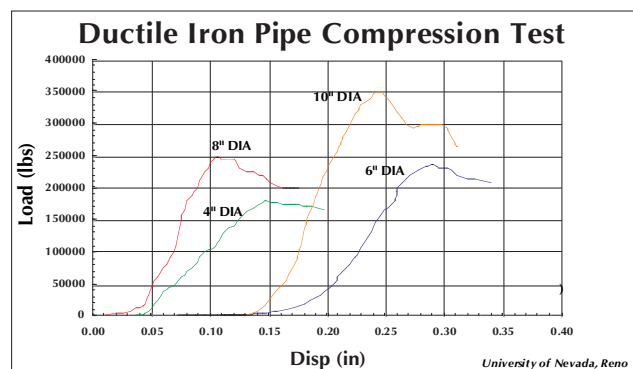

■ Figure 2. Results of Preliminary Tests on Ductile Iron Bell-Spigot Joints (Phase I)

Related MCEER Research Activities

- *Calibration of Fragility Estimation and Development of Fragility Information, A. Reinborn, University at Buffalo*
- *Experimental Facilities Network, A. Reinborn and M.C. Constantinou, University at Buffalo*

be seen that, except in the case of 8 inch diameter pipe, there are measurable amounts of seating distance that had to be overcome before the joints exhibited any resistance to load. As expected, the strength of pipe joints is proportional to the pipe diameter. At the end of the tests, one specimen was cut in half longitudinally to observe the failure mechanism (Figure 3). The failure mechanism can be described as a telescoping of the spigot end into the bell and a subsequent buckling and fracture of the spigot end.

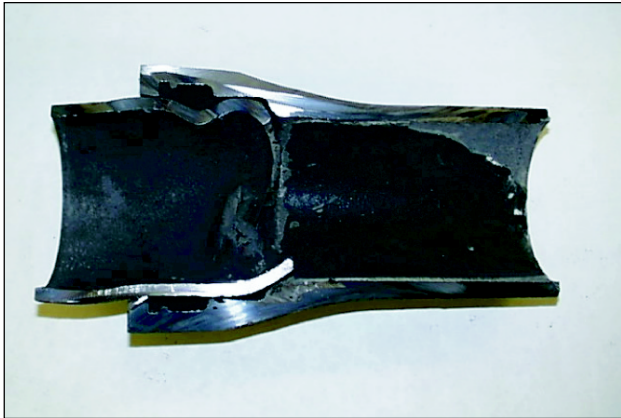

■ Figure 3. Failure Mechanism in Ductile Iron Pipe in Phase I Testing

Test Setup and Loading Configuration (Phase II)

A self-contained steel loading frame was designed and fabricated (Figures 4 and 5) that allows an actuator to apply axial compression and/or tension load to a test specimen

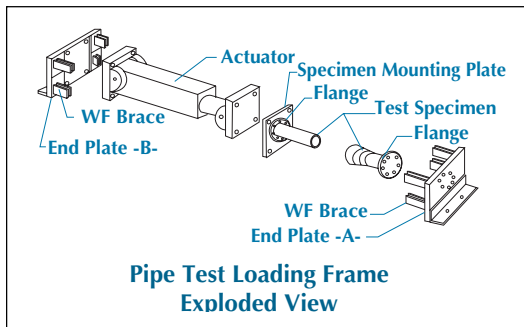

■ Figure 4. Specially Designed Self-contained Steel Loading Frame



■ Figure 5. Loading Frame Sitting on Laboratory Floor

without the use of reaction blocks. The loading and the anchoring setup were designed to readily accept various diameters of pipe specimens and to assemble them within a reasonable amount of time. Axial load, both in tension and compression, can be applied in incremental displacement control by an MTS 450k hydraulic actuator. Table 1 provides a list of the tests undertaken using this loading setup. Several pipes of one single pipe size of 8 inch diameter were tested.

The information obtained from testing included load-displacement characteristics of the joint assembly and strains on the pipe barrel. Typically, at some level of loading, noticeable fracture and buckling occurred, indicating pipe failure. However, failure in a pipeline is governed by the leakage which possibly can occur at some point well before fracture. A generalized criterion for leakage failure may be defined as “substantial

■ **Table 1.** Test Matrix Describing Various Pipe Material and Joint Types (Phase II)

Material	Diameter	Joint Type	Comments
Cast Iron (see Figure 6)	8 in	Bell-spigot, lead caulked	Compression load only; fracture occurred in barrel; no distress in bell
Ductile Iron (see Figure 7)	8 in	Bell-spigot, reinforced gasket	Tension load only; max. load = 125 k; ultimate failure of metal teeth in gasket
Ductile Iron (see Figure 8)	8 in	Bell-spigot, bolted restraining collar	Tension load only; max. load = 52 k; fracture at collar wedge screw holes
Steel (see Figure 9)	8 in	Bell-spigot, lap welded	Bi-directional load; fracture occurred in barrel; weld joint very ductile; severe buckling at bell
PVC (see Figure 10)	8 in	Bell-spigot, push-on rubber gasket	Compression load only; spigot extruded into bell end; water seal maintained; no fracture; max. load = 3 k
Polyethylene (PE) (see Figure 11)	8 in	Butt-fused	Bi-directional load; fused joint remained ductile; severe buckling of pipe; fracture occurred at end flange

and continuous leakage.” To detect such leakage failure, the test setup used completely sealed pipe joint specimens that contained water under a small pressure head (3-4 psi). A noticeable drop in water pressure and an observable amount of water leakage indicated leakage failure. The water pressure was monitored and correlated with the load and displacement values to determine load level at leakage.

Load-Displacement Behavior (Phase II)

Figures 6 through 11 provide the plots of load-displacement data recorded in Phase II testing. Tension loads were applied only to joints that were capable of resisting tension. These cases included two ductile iron pipes with joint restraints (Figures 7 and 8), welded steel pipe (Figure 9), and polyethylene pipe (Figure 11). The compressive capacity of the cast iron, ductile iron, steel,

PVC, and polyethylene pipe can be interpreted from the plots as 460 k, 250 k, 85 k, 3 k, and 68 k, respectively. Similarly, the tensile capacity of ductile iron pipe with reinforced gasket, ductile iron pipe with bolted collars, welded steel, and polyethylene pipes are 125 k, 52 k, 125 k, and 52 k, respectively.

Conclusions/Future Research

This testing program establishes axial behavior characteristics and leakage failure levels due to axial (tensile and/or compression) static loading for several different types of pipe material and pipe joints. Static testing will continue for other diameters of pipe. Information gained, especially failure loads, can be used in the design of the next phase of our testing which will use shake-table testing to simulate dynamic loading.

“The project results will enable pipeline designers and manufacturers to effectively quantify the merits of relatively new products such as pipeline joint restraints and polyethylene pipe.”

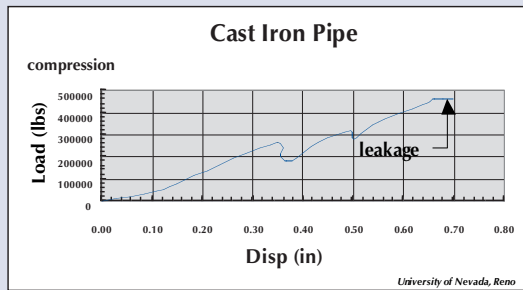

■ Figure 6. Cast Iron Pipe with Lead Caulked Joint

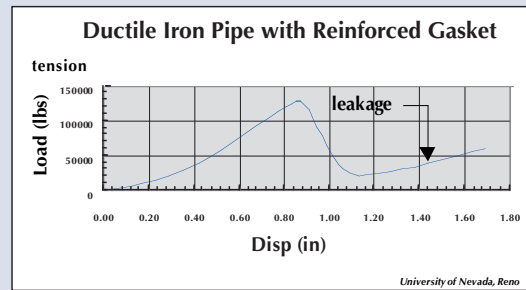

■ Figure 7. Ductile Iron Pipe with Reinforced Gasket

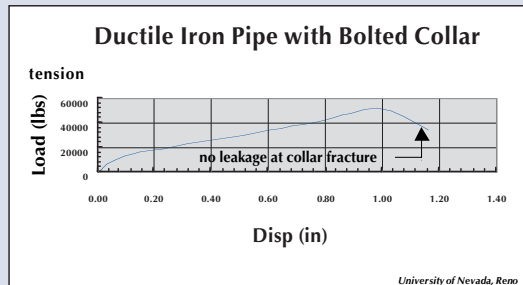

■ Figure 8. Ductile Iron Pipe with Bolted Restraining Collars

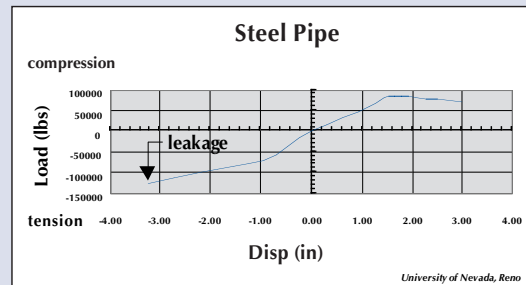

■ Figure 9. Steel Pipe with Bell-spigot Lap-welded Joints

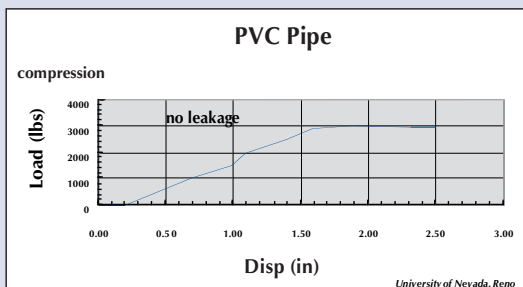

■ Figure 10. PVC with Push-on Rubber Gasketed Joints

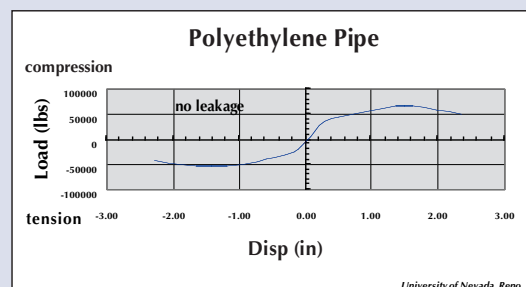

■ Figure 11. Polyethylene (PE) Pipe with Butt-fused Joints

References

- Iwamatu, J., et al., (1998), *Proceedings of Workshop for Anti-Seismic Measures on Water Supply*, IWSA, Tokyo, Japan.
- Kitaura, M. and Miyajima, M., (1996), "Damage to Water Supply Pipelines," *Special Issue of Soils and Foundation*, Japanese Geotechnical Society, January, pp. 325-333.
- O'Rourke, T., (1996), "Lessons Learned for Lifeline Engineering from Major Urban Earthquakes," *Proceedings of the Eleventh World Conference on Earthquake Engineering*, Pergamon, Elsevier Science Ltd., Oxford, England, Disk 4, Paper No. 2172.
- O'Rourke, T. and Palmer, M., (1996), "Earthquake Performance of Gas Transmission Pipelines," *Earthquake Spectra*, Vol. 12, No. 3, August, pp. 493-527.
- Singhal, A., (1984), "Nonlinear Behavior of Ductile Iron Pipeline Joints," *Journal of Technical Topics in Civil Engineering*, Vol. 110, No. 1, May, pp. 29-47.
- Trifunac, M. and Todorovska, M., (1997), "Northridge, California, Earthquake of 1994: Density of Pipe Breaks and Surface Strains," *Soil Dynamics and Earthquake Engineering*, Vol. 16, pp. 193-207.
- Wang, L. and Li, H., (1994), "Experimental Study on the Damping and Resistant Characteristics of Conventional Pipe Joints," *Proceedings of the Fifth U.S. National Conference on Earthquake Engineering*, Earthquake Engineering Research Institute, Oakland, California, Vol. II, pp. 837-846.

Seismic Performance Analysis of Electric Power Systems

by Masanobu Shinozuka and Tsen-Chung Cheng, University of Southern California; Maria Q. Feng, University of California, Irvine; and Sheng-Taur Mau, New Jersey Institute of Technology

Research Objectives

The objectives of this research are to evaluate the seismic performance of the Los Angeles Department of Water and Power's (LADWP's) electric power system, particularly its substations, and recommend appropriate rehabilitation measures. More specifically, it will provide the analytical and empirical foundation to estimate direct economic losses, as well as indirect economic losses suffered by society at large due to seismically induced degradation of the LADWP's power system. Indirect losses include commercial and industrial activities in the Los Angeles metropolitan area affected by service interruption of the electric power system. This research will use the results from the inventory survey and equipment rehabilitation study being performed concurrently primarily by the members of this research team to examine the extent of mitigation enhancement such rehabilitation work can produce. The analysis requires a somewhat elaborate systems analysis of LADWP's power system with primary emphasis on the substation performance under damaging earthquakes such as the 1971 San Fernando and 1994 Northridge earthquakes.

While emergency repair and power supply was accomplished rapidly in the aftermath of the 1994 Northridge earthquake (one day) and the 1995 Kobe earthquake (three days), the costs of full restoration of their electric power systems was extremely high. Estimated direct costs were said to be approximately \$500 million and \$4 billion for the Northridge and the Kobe earthquakes, respectively. Since the "big one" appears to be imminent in California, a much longer and more costly interruption of electric power may have to be anticipated, which could have overwhelming socioeconomic impacts in the affected region. This research will help find rehabilitation measures to mitigate such impacts.

The MCEER research team on system performance evaluation has a unique capability of modeling lifeline systems and carrying out a seismic performance evaluation, given inventory data, system configuration and fragility information with or without rehabilitation. The evaluation requires the delicate coordination of various technologies involving interpretation and manipulation of sophisticated and voluminous inventory data, utilization of highly specialized computer codes for systems analysis, estimation of fragility enhancement resulting from the advanced rehabilitation

Sponsors

MCEER/NSF

Collaborative Partners

Min-Hsiung Chien, formerly of the Los Angeles Department of Water and Power
Nobuo Murota, Bridgestone Company, Japan
Donald Penn, Los Angeles Department of Water and Power

Links to Current Research

- LADWP is an important partner in this effort, providing the MCEER research team with inventory and operational information of its electric power system and some statistics of the damage sustained by the system from the past earthquakes.
- Effort is being made to entice Southern California Edison to participate in MCEER's research as an industry partner.
- A Memorandum of Understanding is being prepared between MCEER and the National Center for Research on Earthquake Engineering (NCREE) in Taipei, Taiwan to perform a joint experimental study on transformers using the shaking table in Taipei.
- MCEER investigator **M. Feng**, University of California, Irvine, is collaborating with **N. Murota**, on leave from Bridgestone Company, in the planning and preparation of shake table testing.

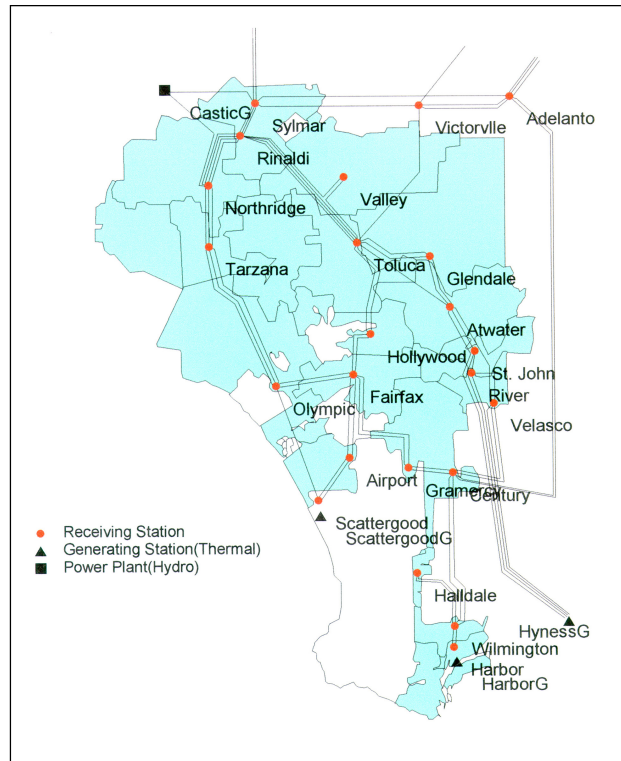

■ Figure 1. Service Areas of LADWP

technology and integration of all the above into a GIS platform for demonstration. This capability itself represents an advanced technology and the purpose of this research effort is to make use of this technology on the Los Angeles Department of Water and Power (LADWP) electric power system.

The Los Angeles Department of Water and Power electric power service areas and the power output

under usual operating conditions in each service area are shown in Figures 1 and 2. The area not colored is serviced by the Southern California Edison. Figure 3 is the Northridge PGA map developed on the basis of the contour map provided by David Wald, U.S. Geological Survey and Figure 4 demonstrates how the system deteriorates under the ground shaking shown in Figure 3 under the hypothesis that only the transformers are

vulnerable to the earthquake with the fragility curves assumed in Figure 5. This is based on the observation that the transformer is one of the most critical pieces of equipment for the functionality of the power network system. The effect of other equipment such as circuit breakers, disconnect switches and buses on the system performance is currently being studied. These hypotheses are introduced to demonstrate the

Primary users of this research include both LADWP's power division and water division because of potential interactive effects, as well as utility companies throughout the U.S. and elsewhere. The research results can further be used by government agencies such as the California State Office of Emergency Services for pre-event and post-event mitigation planning and by private-sector organizations including insurance and financial companies. Another important group of users include researchers in lifeline earthquake engineering, and providers of information for loss estimation databases and methodologies such as HAZUS.

proof of concept in relation to the analytical simulation work used in this research. Figure 4 shows the system deterioration by computing the average ratio of power output relative to that associated with the system under undamaged conditions for each service area. The system analysis utilizes a Monte Carlo simulation method under the hypothetical fragility curves (Cases 1, 2, and 3) provided in Figure 5. Fragility curves (Case 1) were used by Tanaka et al. (1996) for substation equipment. The sample size is equal to 20 for each Monte Carlo simulation analysis. The increasingly improved system performance as fragility curves move to the right (Case 1 to Case 2 and to Case 3) indicates the extent to which the rehabilitation or retrofit of transformers as represented by enhanced fragility curves contributes to improved system performance. This is conceptually not an unreasonable approach for evaluation of the effect of the rehabilitation or retrofit. In fact, M. Shinozuka (1998) gave an example (Figure 6) of such fragility curve enhancement involving a typical Memphis bridge retrofitted by a base isolator in which major damage was assumed to occur when the ductility demand at all the bridge columns exceeded 2.0.

In the present research, reliable fragility curves for the transformers rehabilitated or not rehabilitated are still in the process of being developed. The FPS (Friction Pendulum System) was considered for enhancing the fragility of the LADWP's

transformers. Analytical simulations were performed for a typical transformer weighing 230,000 lbs. subjected to the ground acceleration time histories observed at the Sylmar substation during the 1994 Northridge earthquake. To evaluate the effectiveness of the FPS for a wide range of earthquake intensities, time histories were linearly scaled up to achieve higher PGA values for the development of fragility information. Figure 7 shows that the degree of reduction in the inertia exerted on the transformer depends on the time histories with differing levels of PGA (0.5 g, 1.0 g, and 1.5 g). The trend observed from Figure 7 is that: (1) the FPS is more effective

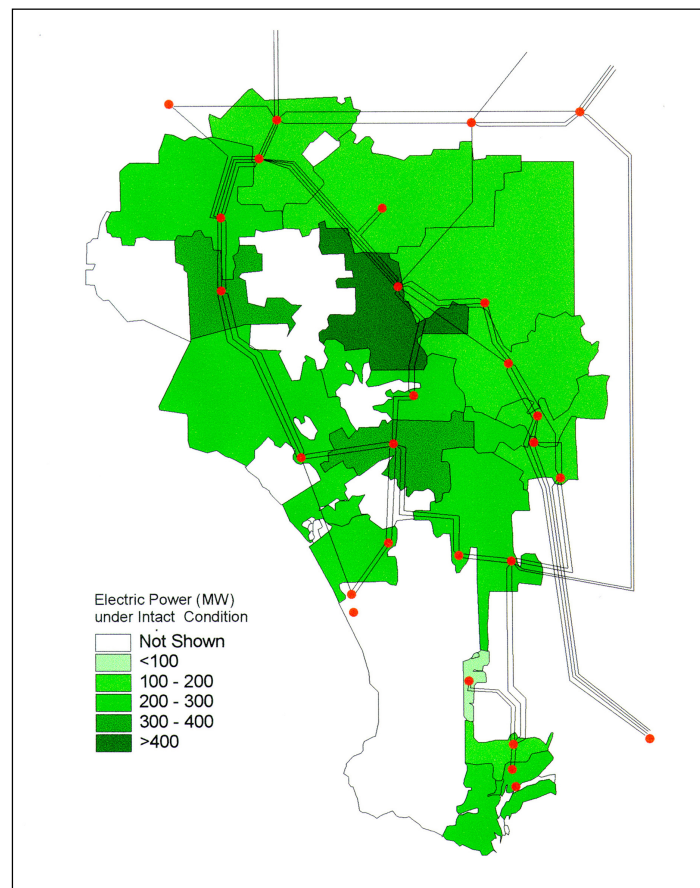

■ Figure 2. Electric Power Output for Service Areas Under Intact Condition

for earthquakes with larger PGA's; (2) the reduction of acceleration exerted on the transformer is more significant when FPS' radius is larger at the expense of larger displacements. Since most transformers are installed outside and have sufficient clearance with neighboring equipment and buildings, larger displacements may not represent a serious obstacle in deploying FPS devices; and (3) in general, for a reasonable size of radius (say 15 inches), the reduction ranges from 30% to 50% depending on the earthquake intensity between 0.5 g to 1.5 g in terms of PGA. This result was generally consistent with hypothetical fragility curve enhancement introduced in Figure 5.

LADWP's Power System

There are two electric power networks serving the Los Angeles region operated by different organizations, Los Angeles Department of Water and Power, and Southern California Edison. Basically, these networks are managed independently. However, for coping with the fluctuating power demand, they cooperate with each other at several substations and operate the system from a regional point of view. In addition, since the networks are a part of the very large Western Systems Coordinating Council's (WSCC) power transmission network covering 14 western states, two Canadian provinces and northern Baja California, the analysis was performed by taking all the substations and transmission facilities covered by the WSCC network into account. Indeed, the fact that a black-out condition was observed over several states after the Northridge earthquake demonstrates the far-reaching impact of a local system failure throughout the network.

In analyzing the functional reliability of each substation, the following modes of failure were taken into consideration: (1) loss of connectivity, (2) failure of the substation's critical components, and (3) power system imbalance. It was noted that most of the transmission lines of the LADWP's power system are aerial supported by transmission towers. While by no means this implies that the transmission lines are completely free from seismic vulnerability, it was assumed in this study that

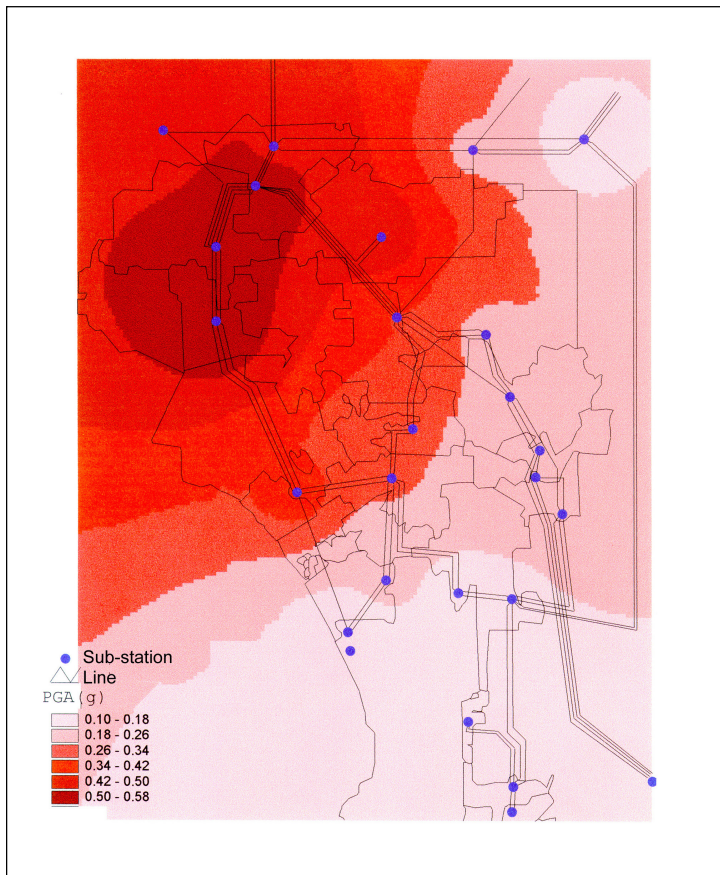

■ Figure 3. PGA Under Northridge Earthquake

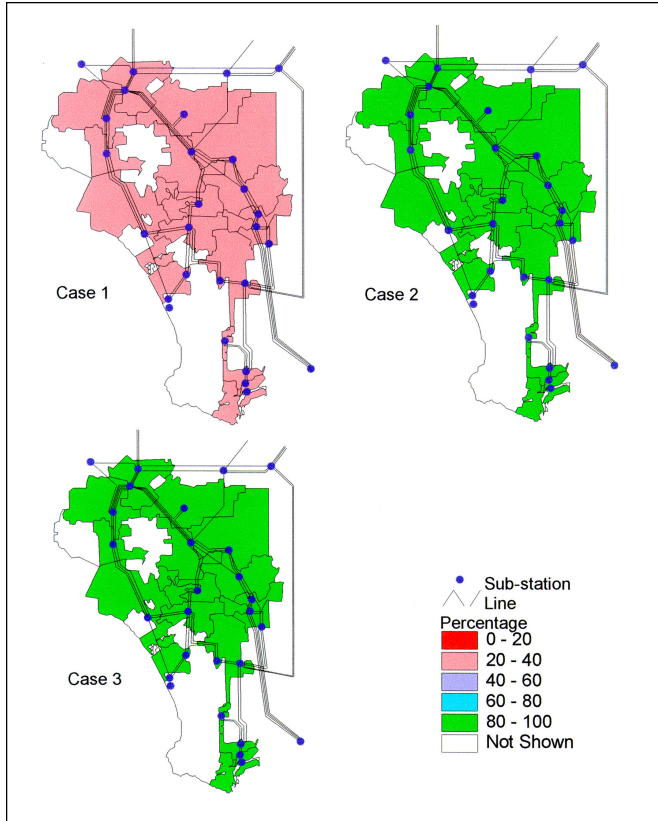

■ Figure 4. Relative Average Power Output (Damaged/Intact) with Transformers Vulnerable

they were, primarily for the purpose of analytical simplicity. Figure 8 shows an abbreviated system flowchart for LADWP's power system with all the substations identified together with the nodes, generators and transformers. Thick horizontal bars represent the nodes (buses with all other associated equipment) in substations as described by a model shown in Figure 9. In the systems analysis pursued here, however, substation data were taken from the WSCC's database and used for the systems analysis in conjunction with the computer code IPFLOW, (version 5.0), licensed by the Electric Power Research Institute (EPRI) to the University of Southern California.

Monte Carlo Simulation

Using the ARC/INFO GIS capability, the electric transmission network map was overlaid with the PGA map (Figure 3) to identify the PGA value associated with each substation under the Northridge earthquake. The fragility curves assumed in Figure 5 were then used to simulate the state of damage involving the transformers at all the substations of the LADWP's power system. For each

systems analysis, the connectivity and power flow were examined with the aid of IPFLOW, where LADWP's power system was treated as a part of WSCC's overall system.

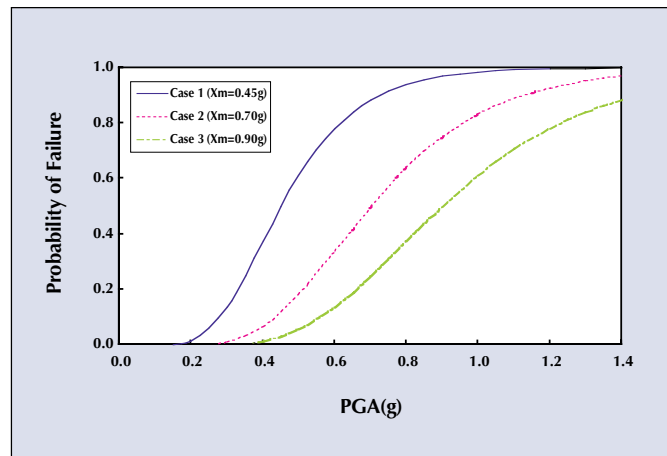

■ Figure 5. Fragility Curves

Related MCEER Research Activities

- *Seismic Reliability Analysis for Southern California Power Systems*, **T.C. Cheng**, University of Southern California
- *Rehabilitation Strategies for Lifelines: LADWP Water Systems*, **T.D. O'Rourke**, Cornell University
- *Seismic Retrofit Methods for LADWP Power Systems*, **S.T. Mau**, New Jersey Institute of Technology and **M. Feng**, University of California, Irvine
- *Socioeconomic Impacts of Lifeline Systems*, **S. Chang**, University of Washington

“The research results can be used by government agencies such as the California State Office of Emergency Services for pre- and post-event mitigation planning and by private-sector organizations including insurance and financial companies.”

Loss of connectivity occurs when the node of interest survives the corresponding PGA, but is isolated from all the generators due to the malfunction of at least one of the nodes on each and every possible path between this node and any of the generators. Hence, the loss of connectivity can be confirmed on each damage state by actually verifying the loss of connectivity with respect to all the paths that would otherwise establish the desired connectivity.

As for abnormal power flow, it was noted that the electric power transmission system was highly sensitive to the power balance and ordinarily some criteria are used to judge whether or not the node continues to function immediately after internal and external disturbances. Two kinds of criteria are employed at each node for the abnormal power flow: power imbalance and abnormal voltage. When the network is damaged due to an earthquake, the total generating power becomes greater or less than the total power demand. Under normal conditions, the balance between power generation and demand is within a certain range of tolerance. Actually, the total power generation must be between 1.0 and 1.05 times the total demand for normal operation even accounting for power transmission loss.

In this study, it was assumed that if this condition was not satisfied,

the operator of the electric system must either reduce or increase the power generation to keep the balance of power. However, in some cases, the supply cannot catch up with the demand because the generating system is unable to respond quickly enough. In this case, it was assumed that the power generation of each power plant cannot be increased or reduced by more than 20% of the current generating power. When the power balance cannot be maintained even after increasing or reducing the generating power by 20%, the system was assumed to be down due to a power imbalance. In this respect, the effect of the emergency management systems used for power flow management will

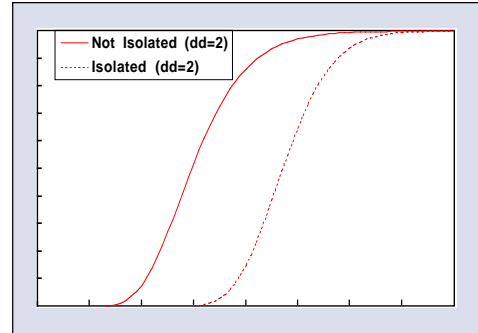

■ Figure 6. Fragility Curves for Bridges with and without Base Isolation

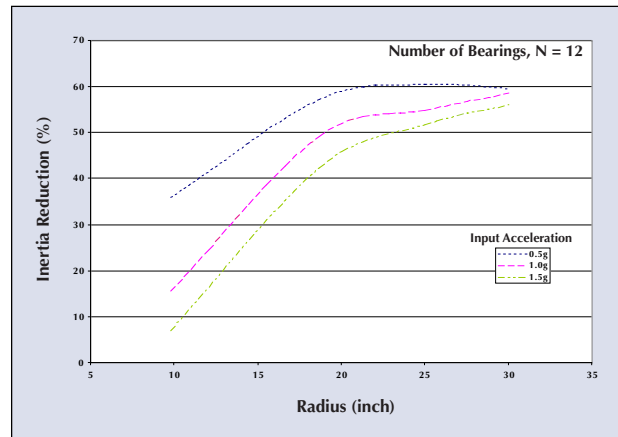

■ Figure 7. Acceleration Reduction by FPS Bearings

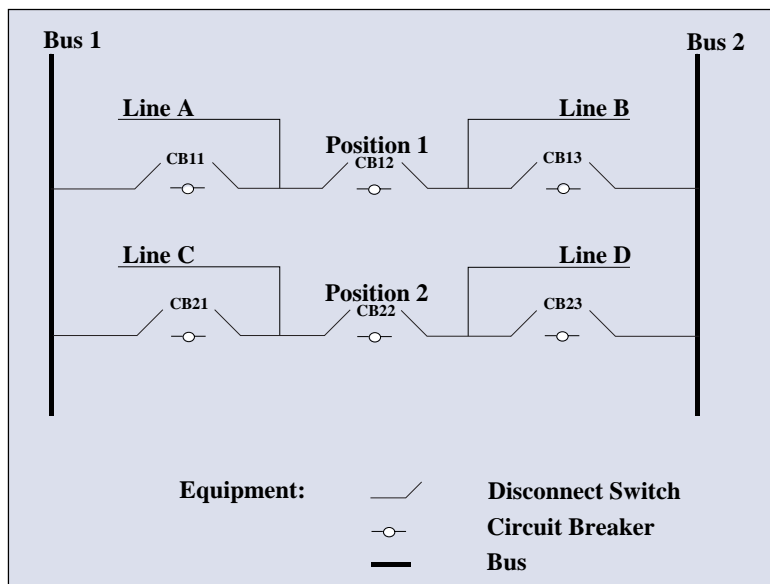

■ Figure 9. Typical Node Configuration Model

In cooperation with Professor C.H. Loh, Director of the National Center for Research on Earthquake Engineering (NCREE) in Taipei, Taiwan, the MCEER team with Bridgestone Company as an industrial partner, is participating in an experiment to verify the effectiveness of FPS and hybrid friction and elastometric base-isolators designed, manufactured and tested by Bridgestone. The experiment will be performed in July 1999 on a transformer model installed with a typical porcelain bushing. For the experiment, NCREE's 5 m x 5 m triaxial shaking table will be used.

On-going Research Activities

Figure 4 is based on the hypothesis that transformers are the only vulnerable equipment under the earthquake and that their fragility curves are given by the three curves in Figure 5. Other equipment such as circuit breakers, buses, and disconnect switches are currently being incorporated into the systems analysis.

In order to examine the adequacy of the fragility assumptions for transformers and other equipment, a walk-down at LADWP's Sylmar substation is scheduled on June 11, 1999 by S.T. Mau (and/or Professor M.A. Saadeghvaziri) of the New Jersey Institute of Technology, M. Shinozuka (and/or Mr. X. Dong and Professor F. Nagashima) and T.C. Cheng (and/or Mr. X. Jin) of the University of Southern California, and Professor M. Feng (and/or Mr. N. Murota) of the University of California, Irvine.

Future Research

Now that all the analytical tools are in place, in the year immediately following and beyond, the research will continue to proceed on three fronts. The first is to refine the systems analysis methodology by incorporating all significant substation equipment and validating the results of the analysis with data from power interruption experiences caused by the Northridge and Kobe earthquakes. Upon validation, other scenario earthquakes will be considered for the systems analysis to examine the seismic performance of LADWP's power system under a wide variety of earthquake magnitudes, epicentral locations and seismic source mechanisms. Interaction between LADWP's power and water systems will also be considered. This requires, however, additional effort for inventory and other database development.

The second is to further study seismic vulnerability of the equipment and develop their fragility curves. In this regard, the results from the research carried out by the MCEER investigators on fragility information will be used as they become available. Rehabilitation measures can then be expressed as fragility curve enhancements, which can in turn be directly reflected on the systems analysis with the aid of Monte Carlo techniques. In this connection, rehabilitation measures other than those by base isolation will be explored. Possibilities include use of advanced semi-active dampers. The shaking table tests for transformers will be completed and the continued MCEER-NCREE collaboration will lead to additional tests involving other equipment to determine their fragility characteristics and enhancement measures.

The third area of future endeavor involves direct and indirect economic loss estimation arising from physical damage to the sys-

tem facilities and resulting possible system interruption. This endeavor expands the MCEER team's capability in this area demonstrated by the study of the seismic vulnerability of the Memphis area's electricity lifelines (see Shinozuka et al., 1998). To assist the MCEER investigators in loss estimation, the Monte Carlo simulation will be performed in such a way that direct and indirect loss estimation will be pursued by recording a specific inventory of equipment damage observed for each realization of system damage. As detailed in Shinozuka and Eguchi (1997), this allows statistics on direct and indirect losses based on individual states of damage associated with corresponding simulation to be obtained, rather than based on the average of the power output taken over the entire sample of simulation.

References

- Shinozuka, M. and Eguchi, R., (1997), "Seismic Risk Analysis of Liquid Fuel Systems A Conceptual and Procedural Framework for Guidelines Development," *Proceedings of The Northridge Earthquake Research Conference*, Los Angeles, California, August 20-22.
- Shinozuka, M., (1998), "Development of Bridge Fragility Curves," *Proceedings of the U.S.-Italy Workshop on Protective System for Bridges*, New York, April 26-28.
- Shinozuka, M., Rose, A. and Eguchi, R.T., (eds.), (1998), *Engineering and Socioeconomic Impacts of Earthquakes: An Analysis of Electricity Lifeline Disruptions in the New Madrid Area*, Monograph No. 2, Multidisciplinary Center for Earthquake Engineering Research, Buffalo, New York.
- Tanaka, S., Shinozuka, M., Schiff, A. and Kawata, Y., (1997), "Lifeline Seismic Performance of Electric Power Systems during the Northridge Earthquake," *Proceedings of The Northridge Earthquake Research Conference*, Los Angeles, California, August 20-22.

National Representation of Seismic Hazard and Ground Motion for Highway Facilities

by Maurice S. Power and Shyh-Jeng Chiou, Geomatrix Consultants, Inc., and Ronald L. Mayes, Dynamic Isolation Systems, Inc. for the Applied Technology Council

Research Objectives

The objective of this research is to develop recommendations for the national representation of seismic hazard and ground motion for the seismic design of highway bridges and other highway structures. This includes: (1) the selection and utilization of national ground motion maps; (2) the representation of site response effects; and (3) the possible incorporation of other parameters and effects, including energy or duration of ground motions, vertical ground motions, near-source horizontal ground motions, and spatial variations of ground motions.

MCEER, through the Federal Highway Administration (FHWA) sponsored Highway Project, is conducting research to develop improved criteria and procedures for the seismic design of new highway facilities and the seismic evaluation and retrofit of existing highway facilities. An important area of research is new directions for representing seismic hazard and ground motions in nationally applicable guidelines and specifications, including the AASHTO seismic design specifications for bridges and the FHWA/ MCEER seismic evaluation and retrofitting manual for bridges and other highway structures.

Some of the key seismic ground motion representation issues are: (1) selection and utilization of national ground motion maps; (2) representation of site response effects; and (3) incorporation of other parameters and effects, including ground motion energy or duration, vertical ground motions, near-source horizontal ground motions, and spatial variations of ground motions. These issues were discussed in some detail at the *MCEER Workshop on National Representation of Seismic Ground Motion for New and Existing Highway Facilities*, May 29 and 30, 1997, in San Francisco (Friedland et al., 1997).

In addition, in August 1998, the ATC/MCEER Joint Venture, a partnership of the Applied Technology Council (ATC) and MCEER, was awarded a contract by the AASHTO-sponsored National Cooperative Highway Research Program (NCHRP) of the Transportation Research Board, National Academy of Sciences, to develop a comprehensive new specification for the seismic design of bridges (NCHRP Project 12-49). The research and

Sponsors

MCEER Highway Project
National Cooperative Highway
Research Program
Transportation Research
Board

Collaborative Partners

Applied Technology Council

Links to Current Research

- *This project is reviewing and assessing the results from research currently in progress or recently completed in other MCEER projects, U.S. Geological Survey, Caltrans, the Federal Highway Administration, and others for its possible incorporation into the recommendations that are being developed.*

Related Highway Project Tasks

- *Compile and Evaluate Maps and Other Representations and Recommend Alternative Strategies for Portraying the National Hazard Exposure of Highway Systems*, **M. Power**, Geomatrix Consultants, Inc.
- *Development of a Unified Model of Spatial Variation*, **M. Shinozuka**, University of Southern California, and **G. Deodatis**, Princeton University
- *Northridge SRI4/15 Case Study: Structural Implications*, **A. Reinborn**, University at Buffalo
- *Two-Dimensional Nonlinear Site Response Analysis*, **G. Martin**, University of Southern California
- *Evaluation of Site Coefficients Based on Northridge and Kobe Data*, **R. Dobry**, Rensselaer Polytechnic Institute
- *Vertical Seismic Ground Motions*, **M. Power**, Geomatrix Consultants, Inc.
- *Site Response Effects*, **R. Dobry**, Rensselaer Polytechnic Institute
- *Effects of Vertical Acceleration on Structural Response*, **M. Butten**, Dynamic Isolation Systems

development effort being undertaken on this project is the development of new Load and Resistance Factor Design (LRFD) Specifications and Commentary for the seismic design of bridges. Issues being addressed include: (1) design philosophy and performance criteria; (2) seismic loads and site effects; (3) analysis and modeling; and (4) design and detailing requirements. The new specification must be nationally applicable with provisions for all seismic zones. The results of research currently in progress or recently completed by MCEER, Caltrans, and the FHWA are the principal resources for this project.

Selecting & Using National Ground Motion Maps

One of the most important issues addressed by the MCEER Highway Project is whether new (1996) national ground motion maps developed by the U.S. Geological Survey (USGS) (Frankel et al., 1996) should be recommended to provide a national representation of seismic ground motion for bridges and highways. The new set of maps contour elastic 5%-damped response spectral accelerations for periods of

vibration of 0.2, 0.3, and 1.0 second and peak ground acceleration for probabilities of exceedance of 10%, 5%, and 2% in 50 years (corresponding approximately to return periods of 500, 1000, and 2500 years, respectively). A key question is whether the new USGS maps provide a substantially improved scientific national representation of ground motion. The MCEER Highway Project and the May 1997 MCEER Workshop concluded based on an evaluation of (1) the process by which the maps were prepared, (2) characterizations of seismic sources and ground motion attenuation used in the mapping, and (3) comparison of the map values with results from detailed site-specific studies, that the new USGS maps provided a major improvement in the representation of seismic ground motion at a national scale and therefore should provide the basis for a new national seismic hazard portrayal for highway facilities. The NCHRP project intends to use these maps as the basis for defining seismic loads for the new seismic design provisions for bridges. Similarly, the maps will be used as a basis for defining seismic loads for the FHWA/MCEER seismic retrofitting manual (see *Seismic*

The recommendations will be incorporated in a new set of seismic design provisions that will be considered for adoption by the American Association of State Highway Transportation Officials (AASHTO). If and when they are adopted, they will be used by all Federal, State, and local transportation agencies and departments, and private organizations involved in the design and operation of new highway bridges. The recommendations will also be incorporated in a set of retrofitting manuals for existing bridges and other highway structures being developed by MCEER (see *Seismic Retrofitting Manual for Highway Systems* in this report). Users of these manuals will be similar to that of the AASHTO seismic design specifications for new bridges.

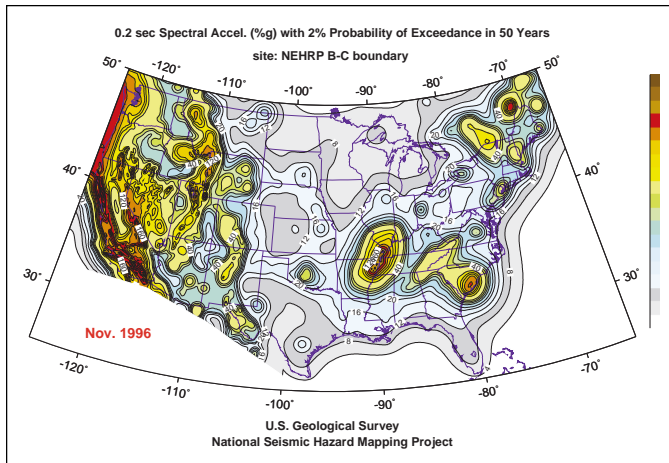

■ Figure 1. U.S. Geological Survey 0.2 second 2,500 Year Spectral Acceleration Map

Retrofitting Manual for Highway Systems in this report).

A key issue in the utilization of the new USGS maps is the choice of an appropriate probability of exceedance or return period for seismic design provisions i.e., whether to continue with the 10% probability of exceedance in 50 years in existing AASHTO provisions or recommend another probability level. The May 1997 MCEER Workshop recommended that for a prevention-of-collapse performance criterion, probability of exceedance levels lower than 10% in 50 years should be considered in design. This recommended direction is consistent with revisions to the 1997 National Earthquake Hazards Reduction Program (NEHRP) Provisions for new buildings (BSSC, 1997a) in which the new USGS maps for a probability of exceedance of 2% in 50 years have been selected as a collapse prevention design basis for buildings (see Figure 1). The NCHRP 12-49 project recommended for the seismic design of new bridges: (1) elastic design for expected ground motions, defined as ground motions having a probability of exceedance

of 50% during the design life of a bridge, taken as 75 years; and (2) design for collapse prevention for rare or maximum-earthquake ground motions, defined as ground motions having a probability of exceedance of 3% in 75 years. These probability levels correspond, respectively,

to return periods of approximately 100 years and 2,500 years. No recommendations regarding probability levels or return periods have yet been developed for seismic retrofit design for existing

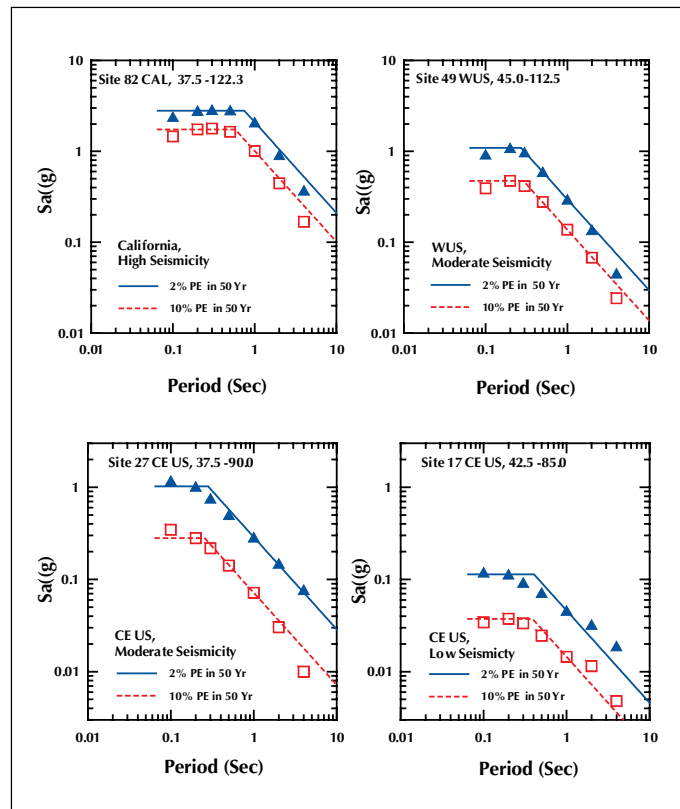

■ Figure 2. Comparison of Simplified Response Spectrum Construction Procedure in 1997 NEHRP Provisions with Spectral Accelerations Computed by USGS for National Ground Motion Mapping

“Site response effects for code provisions are best characterized at present by the site categories and site factors developed at the 1992 Site Effects Workshop and subsequently adopted into the 1994 and 1997 NEHRP Provisions and the 1997 Uniform Building Code.”

bridges. If an approach were taken similar to that in the NEHRP guidelines for existing buildings (BSSC, 1997b), then, for planned retrofits, a bridge owner could select from among a range of ground motion probability levels and retrofitting performance objectives, depending on economic factors and the owner’s objectives.

In the 1997 NEHRP provisions for buildings, a simple procedure was proposed for constructing a response spectrum using spectral accelerations from national ground motion maps (see Figure 2). The procedure consists of intersecting a constant-spectral-acceleration plateau defined by the mapped spectral

acceleration at 0.2-second period with a long period branch that declines as $1/T$ ($T =$ period) and passes through the mapped spectral acceleration at 1.0-second period. This procedure has been evaluated by comparing the resulting spectra with spectral accelerations computed by the USGS at a larger number of periods (0.1, 0.2, 0.3, 0.5, 1.0, 2.0, and 4.0 seconds) for different tectonic environments and geographic locations throughout the United States. The proposed NEHRP simplified response spectrum construction procedure generally is in good agreement with the computed spectral accelerations in the period range of 0.2 to 2 seconds. At short periods (0.1 second) and longer periods (4 seconds), the simplified

spectrum is generally conservative. Overall, these spectral comparisons indicate that the simplified response spectrum construction procedure is adequate. The decline of spectral accelerations as $1/T$ in the long-period range is a better characterization of long-period ground motions than the $1/T^{2/3}$ decline incorporated in the current AASHTO provisions.

Representing Site Response Effects

The current AASHTO provisions characterize site response effects on ground motion using the S1 through S3 site categories and corresponding site factors that were originally developed in the ATC-3

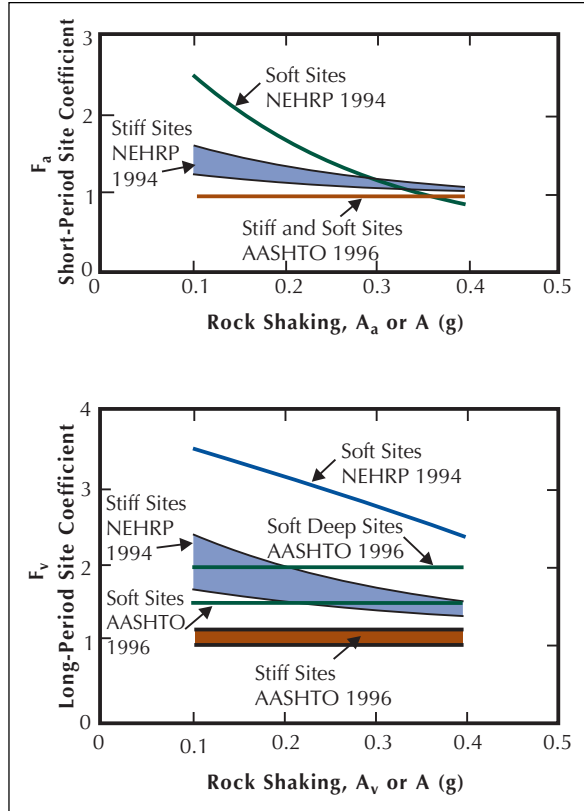

■ **Figure 3.** Comparison of Site Coefficients Contained in 1997 NEHRP, 1997 Uniform Building Code and 1996 AASHTO Specifications for Highway Bridges

Project (ATC, 1978), and the S4 category which was added after the 1985 Mexico City earthquake. The May 1997 MCEER Workshop considered whether these site factors and site categories should be replaced by the site categories and site factors developed at a Site Effects Workshop sponsored by MCEER, SEAOC, and BSSC and held in 1992 at the University of Southern California (USC) (Martin and Dobry, 1994), and subsequently adopted in the 1997 Uniform Building Code and 1994 and 1997 NEHRP Provisions.

Since the 1992 Workshop, two significant earthquakes occurred, the 1994 Northridge and the 1995 Kobe earthquakes. These earthquakes provided substantial additional data for evaluating site effects on ground motions, and research using these data has been conducted. Dobry et al. (1997, 1998) and Borchardt (1996, 1997) presented results indicating that the new site factors developed at the USC Workshop are in fairly good agreement with data from the Northridge earthquake for stiff soil sites, and Borchardt (1996, 1997) found similar agreement for soft soil site data from the Kobe earthquake. Borchardt also found that the effects of soil nonlinearity (reducing site amplifications with increasing levels of excitation) might be somewhat smaller than those incorporated in the new site factors for stiff soil sites, based on preliminary analyses of Northridge earthquake data (see Figure 3). The May 1997 MCEER Workshop concluded that, overall, the post-Northridge and post-Kobe earthquake research conducted to date supported the new site factors, although revisions to these factors

should be considered as further research on site effects is completed. The Workshop therefore recommended that these site factors be proposed as part of a new national representation of seismic ground motion for highway facilities design. It was also concluded that these site factors should not be coupled with the conservative long-period response spectral characterization in the current AASHTO provisions (spectral values decaying as $1/T^{2/3}$). Rather, long-period ground motions should be permitted to decay in a more natural fashion (approximately as $1/T$), as discussed above (see Figure 4).

Incorporating Energy and Duration of Ground Motions

At present, the energy or duration of ground motions is not explicitly recognized in the design process for bridges or buildings, yet many engineers are of the opinion that

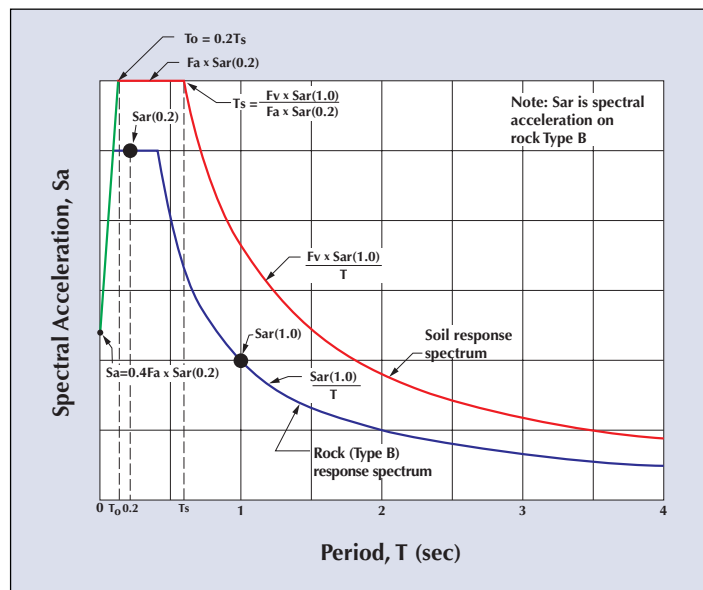

■ Figure 4. Proposed Rock and Soil Response Spectra Definition in 1997 NEHRP Provisions

the performance of a structure may be importantly affected by these parameters in addition to the response spectral characteristics of ground motion. On the basis of papers and presentations at the May 1997 MCEER Workshop by Cornell (1997), Krawinkler (1997), and Mander and Dutta (1997), it was concluded that some measure of the energy of ground motions is important to the response of a bridge but, currently, there is no accepted design procedure to account for energy. Research in this area should be continued in order to develop energy-based design methods that can supplement current elastic-response-spectrum-based design methods. The MCEER Workshop also concluded that energy, rather than duration, of ground motions is the fundamental parameter affecting structural behavior.

Incorporating Vertical Ground Motion

At present, the AASHTO specifications for bridges do not contain explicit requirements to design for vertical accelerations. Ground motion data from many earthquakes in the past 20 years have shown that, in the near-source region, very high short-period vertical response spectral accelerations can occur. For near-source moderate- to large-magnitude earthquakes, the rule-of-thumb ratio of two-thirds between vertical and horizontal spectra is a poor descriptor of vertical ground motions; at short periods, the vertical-to-horizontal spectral ratios can substantially exceed unity, whereas at long periods, a ratio of two-thirds may be conservative

(e.g., Silva, 1997). Our current understanding and ability to characterize near-source vertical ground motions is good, especially for the Western United States. Furthermore, analyses by Foutch (1997) and Gloyd (1997) have demonstrated that high vertical accelerations, as may be expected in the near-source region, can significantly impact bridge response and design requirements in some cases. On the basis of these findings, the May 1997 MCEER Workshop concluded that vertical ground motions should be considered in the design of some types of bridges in the near-source region and that specific design criteria and procedures should be formulated. The NCHRP 12-49 project is addressing this issue based on more recent MCEER-sponsored work (Button et al., 1999).

Representing Near-Source Horizontal Ground Motions

It is well established that, in addition to the increasing amplitude of ground motions (in terms of peak ground acceleration, spectral acceleration, etc.) with decreasing distance to earthquake sources, near-source ground motions have certain characteristics that are not found at greater distances. For horizontal ground motions, the most significant characteristic appears to be a large pulse of intermediate- to long-period ground motions when an earthquake rupture propagates toward a site. Furthermore, this pulse is larger in the direction perpendicular to the strike of the fault than in the direction parallel to the strike (e.g.,

Somerville et al., 1997, Somerville, 1997). This characteristic of near-source ground motions has been observed in many earthquakes, including most recently in the Northridge and Kobe earthquakes. Preliminary analyses of bridge response by Mayes and Shaw (1997) indicate that near-source ground motions may impose unusually large displacement demands on bridges.

At the May 1997 MCEER Workshop, it was concluded that traditional ground motion characterizations (i.e., response spectra) may not be adequate in the describing near-source ground motions, because the pulsive character of these motions may be more damaging to bridges than indicated by the response spectra of the motions. It was recommended that additional research be carried out to evaluate more fully the effects of near-source ground motions on bridge response and to incorporate these effects in code design procedures. Until adequate procedures are developed, consideration should be given to evaluating bridge response using site-specific analyses with representative near-source acceleration time histories.

Spatial Variations of Ground Motion

Spatial variations of ground motions along an extended structure such as a bridge include spatial incoherency in ground motions, wave passage effects, attenuation effects, and differential site response. For major long-span bridges, procedures are available and have been employed in some cases for taking these effects into

account in relatively sophisticated site-specific analyses (e.g., Power et al., 1993). However, questions remain as to the classes of bridges (e.g., related to bridge span length, overall bridge length, and other characteristics) for which spatial variations of ground motion may safely be neglected in design or the effects of these variations incorporated using simplified code-type design procedures.

Limited studies on effects of spatial variations of ground motions on bridge response (Shinozuka and Deodatis, 1997; Simeonov et al., 1997; and Der Kiureghian and Keshishian, 1997) indicate that, in general, in the absence of strong differential site response effects, the response of “ordinary” highway bridges is not greatly affected by spatial variations of ground motions. However, the MCEER May 1997 Workshop concluded that the bridge categories and conditions for which spatial variations of ground motions can be neglected is not yet well defined, even for the case of relatively uniform soil conditions along a bridge. In a more recent study conducted under the MCEER Highway Project (Shinozuka et al., 1999), it is concluded that, for bridges that are more than 1,000 to 1,500 feet (300 to 450 meters) in overall length or for bridges of any length with foundations supported on different local soil conditions, there can be significant increases in peak relative forces and displacements. The study therefore recommends that time history dynamic analyses be performed for the design of bridges under such conditions. However, further research is needed to broaden these conclusions and recommendations to a wider variety of bridge types and

***“The MCEER
May 1997
Workshop
concluded that
the bridge
categories and
conditions for
which spatial
variations of
ground
motions can be
neglected is
not yet well
defined.”***

construction, and to develop simplified procedures for incorporating the effects of these variations in design.

Conclusions

The principle current conclusions regarding the national representation of seismic hazard and ground motions for highway facilities design are the following: (1) new (1996) USGS national ground motion maps provide a substantially more accurate representation of seismic ground motion than earlier maps and are recommended to provide a basis for a new national seismic hazard portrayal for highway facilities design; (2) for collapse prevention design, probability levels lower than the 10% probability of exceedance in 50 years (i.e., return periods longer than approximately 500 years) currently in AASHTO should be considered for highway facilities design; (3) simplified NEHRP procedures for response spectrum construction appear to be reasonable for periods of vibration equal to or less than 4 seconds; (4) site response

effects for code provisions are best characterized at present by the site categories and site factors developed at the 1992 Site Effects Workshop and subsequently adopted into the 1994 and 1997 NEHRP Provisions and the 1997 Uniform Building Code; (5) code provisions should be formulated for design of some types of bridges for vertical ground motions in the near-source regions; (6) response spectra may not adequately characterize the pulsive character of near-source horizontal ground motions and further work is needed to more fully evaluate the effects on bridge response and develop appropriate analytical procedures; (7) energy-based design methods appear to be promising for supplementing elastic-response spectrum-based design but further work is needed to develop accepted formulations; and (8) in the absence of strong-differential site response, the effect of spatial variations of ground motion on "ordinary" (i.e., not long-span) bridges appears to be small, but the matrix of bridge categories and conditions for which these effects can be safely neglected is not sufficiently defined.

References

- Borcherdt, R.D., (1996), "Preliminary Amplification Estimates Inferred from Strong Ground Motion Recordings of the Northridge Earthquake of January 17, 1995," *Proceedings of the International Workshop on Site Response I*, Vol. 2, Yokosuka, Japan, Port and Harbor Research Institute, Japan.
- Borcherdt, R.D., (1997), "Estimates of Site-Dependent Response Spectra for New and Existing Highway Facilities (Methodology and Justification)," *Proceedings of the FHWA/NCEER Workshop on National Representation of Seismic Ground Motion for New and Existing Highway Facilities*, San Francisco, California, May 29-30, Technical Report NCEER-97-0010, Multidisciplinary Center for Earthquake Engineering Research, Buffalo, New York, pp. 171-201.

- BSSC, (1997a), *NEHRP Recommended Provisions for Seismic Regulations for New Buildings: Part I Provisions; Part II Commentary*, Report FEMA 222A and 223A, Building Seismic Safety Council, Washington, D.C.
- BSSC, (1997b), *NEHRP Guidelines for the Seismic Rehabilitation of Buildings*, Report FEMA-273, and *NEHRP Commentary for the Seismic Rehabilitation of Buildings*, Report FEMA-274, Building Seismic Safety Council, Washington, D.C.
- Button, M., Cronin, C. and Mayes, R., (1999), *Effect of Vertical Ground Motions on the Structural Response of Highway Bridges*, Technical Report MCEER-99-0007, Multidisciplinary Center for Earthquake Engineering Research, Buffalo, New York.
- Cornell, C.A., (1997), "Does Duration Really Matter?," *Proceedings of the FHWA/NCEER Workshop on National Representation of Seismic Ground Motion for New and Existing Highway Facilities*, San Francisco, California, May 29-30, Technical Report NCEER-97-0010, Multidisciplinary Center for Earthquake Engineering Research, Buffalo, New York, pp. 125-133.
- DerKiureghian, A. and Keshishian, P., (1997), "Effects of Incoherence, Wave Passage, and Spatially Varying Site Conditions on Bridge Response," *Proceedings of the FHWA/NCEER Workshop on National Representation of Seismic Ground Motion for New and Existing Highway Facilities*, San Francisco, California, May 29-30, Technical Report NCEER-97-0010, Multidisciplinary Center for Earthquake Engineering Research, Buffalo, New York, pp. 393-407.
- Dobry, R., Ramos, R. and Power, M.S., (1997), "Site Factors and Site Categories in Seismic Codes: A Perspective," *Proceedings of the FHWA/NCEER Workshop on National Representation of Seismic Ground Motion for New and Existing Highway Facilities*, San Francisco, California, May 29-30, Technical Report NCEER-97-0010, Multidisciplinary Center for Earthquake Engineering Research, Buffalo, New York, pp. 137-169.
- Dobry, R., Ramos, R. and Power, M.S., (1999), *Site Factors and Site Categories in Seismic Codes*, Technical Report MCEER-99-0010, Multidisciplinary Center for Earthquake Engineering Research, Buffalo, New York.
- Foutch, D.A., (1997), "A Note on the Occurrence and Effects of Vertical Earthquake Ground Motion," *Proceedings of the FHWA/NCEER Workshop on National Representation of Seismic Ground Motion for New and Existing Highway Facilities*, San Francisco, California, May 29-30, Technical Report NCEER-97-0010, Multidisciplinary Center for Earthquake Engineering Research, Buffalo, New York, pp. 253-275.
- Frankel, A., Mueller, C., Barnhard, T., Perkins, D., Leyendecker, E.V., Dickman, N., Hanson, S. and Hopper, M., (1996), *National Seismic Hazard Maps Documentation*, June 1996, U.S. Geological Survey Open-File Report 96-532.
- Friedland, I.M., Power, M.S. and Mayes, R.L., eds., (1997), *Proceedings of the FHWA/NCEER Workshop on National Representation of Seismic Ground Motion for New and Existing Highway Facilities*, San Francisco, California, May 29-30, Technical Report NCEER-97-0010, Multidisciplinary Center for Earthquake Engineering Research, Buffalo, New York.
- Gloyd, S., (1997), "Design of Ordinary Bridges for Vertical Seismic Acceleration," *Proceedings of the FHWA/NCEER Workshop on National Representation of Seismic Ground Motion for New and Existing Highway Facilities*, San Francisco, California, May 29-30, Technical Report NCEER-97-0010, Multidisciplinary Center for Earthquake Engineering Research, Buffalo, New York, pp. 277-290.
- Krawinkler, H., (1997), "Impact of Duration/Energy in Design," *Proceedings of the FHWA/NCEER Workshop on National Representation of Seismic Ground Motion for New and Existing Highway Facilities*, San Francisco, California, May 29-30, Technical Report NCEER-97-0010, Multidisciplinary Center for Earthquake Engineering Research, Buffalo, New York, pp. 115-123.

- Mander, J.B. and Dutta, A., (1997), "How Can Energy Based Seismic Design be Accommodated in Seismic Mapping," *Proceedings of the FHWA/NCEER Workshop on National Representation of Seismic Ground Motion for New and Existing Highway Facilities*, San Francisco, California, May 29-30, Technical Report NCEER-97-0010, Multidisciplinary Center for Earthquake Engineering Research, Buffalo, New York, pp. 95-114.
- Martin, G.R. and Dobry, R., (1994), "Earthquake Site Response and Seismic Code Provisions," *NCEER Bulletin*, Vol. 8, No. 4, pp. 1-6; and *Research Accomplishments: 1986-1994*, Multidisciplinary Center for Earthquake Engineering Research, Buffalo, New York, pp. 121-120.
- Mayes, R.L. and Shaw, A., (1997), "The Effects of Near Fault Ground Motions on Bridge Columns," *Proceedings of the FHWA/NCEER Workshop on National Representation of Seismic Ground Motion for New and Existing Highway Facilities*, San Francisco, California, May 29-30, Technical Report NCEER-97-0010, Multidisciplinary Center for Earthquake Engineering Research, Buffalo, New York, pp. 319-340.
- Power, M.S., Youngs, R.R., Chang, C.Y., Sadigh, R., Coppersmith, K.J., Taylor, C.L., Penzien, J., Wen, S.T., Abrahamson, N. and Gates, J.H., (1993), "Development of Seismic Ground Motions for San Francisco Bay Bridges." *Proceedings of the First U.S. Seminar, Seismic Evaluation, and Retrofit of Steel Bridges*, San Francisco, October 18, University of California at Berkeley, and California Department of Transportation, Division of Structures.
- Shinozuka, M. and Deodatis, G., (1997), "Effect of Spatial Variation of Ground Motion on Seismic Response of Bridges," *Proceedings of the FHWA/NCEER Workshop on National Representation of Seismic Ground Motion for New and Existing Highway Facilities*, San Francisco, California, May 29-30, Technical Report NCEER-97-0010, Multidisciplinary Center for Earthquake Engineering Research, Buffalo, New York, pp. 343-358.
- Shinozuka, M., Saxena, V. and Deodatis, G., (1999), *Effect of Spatial Variation of Ground Motion on Highway Structures*, Highway Project draft final task report, Task 106-E-2.2/2.5, Multidisciplinary Center for Earthquake Engineering Research, Buffalo, New York, April.
- Silva, W., (1997), "Characteristics of Vertical Strong Ground Motions for Applications to Engineering Design," *Proceedings of the FHWA/NCEER Workshop on National Representation of Seismic Ground Motion for New and Existing Highway Facilities*, San Francisco, California, May 29-30, Technical Report NCEER-97-0010, Multidisciplinary Center for Earthquake Engineering Research, Buffalo, New York, pp. 205-252.
- Simeonov, V.K., Mylonakis, G., Reinhorn, A.M. and Buckle, I.G., (1997), "Implications of Spatial Variation of Ground Motion on the Seismic Response of Bridges: Case Study," *Proceedings of the FHWA/NCEER Workshop on National Representation of Seismic Ground Motion for New and Existing Highway Facilities*, San Francisco, California, May 29-30, Technical Report NCEER-97-0010, Multidisciplinary Center for Earthquake Engineering Research, Buffalo, New York, pp. 359-391.
- Somerville, P.G., (1997), "The Characteristics and Quantification of Near Fault Ground Motion," *Proceedings of the FHWA/NCEER Workshop on National Representation of Seismic Ground Motion for New and Existing Highway Facilities*, San Francisco, California, May 29-30, Technical Report NCEER-97-0010, Multidisciplinary Center for Earthquake Engineering Research, Buffalo, New York, pp. 293-318.
- Somerville, P.G., Smith, N.F., Graves, R.W. and Abrahamson, N.A., (1997), "Modification of Empirical Strong Ground Motion Attenuation Relations to Include the Amplitude and Duration Effects of Rupture Directivity," *Seismological Research Letters*, Vol. 68, pp 199-222.

Updating Assessment Procedures and Developing a Screening Guide for Liquefaction

by T. Leslie Youd,
Brigham Young University

Research Objectives

The main objectives of this research program are to provide consensus updates to standard procedures and prepare guidance documents for assessing liquefaction hazards for highway bridge sites. The scope of these studies includes evaluation of liquefaction resistance of soils with standard and cone penetration tests, shear wave velocity measurements, and Becker penetration tests. Additional issues, such as updated magnitude scaling factors, are addressed. The research findings are incorporated in unified, well-established guidelines for use by practicing engineers.

Liquefaction-induced ground and foundation displacements have been major causes of bridge damage during past earthquakes. The Great Alaskan earthquake of March 27, 1964 marked the commencement of studies to understand and mitigate liquefaction hazard (McCulloch and Bonilla, 1970; Kachadoorian, 1968; Youd, 1993). Over the past 30 years, a procedure, termed the “simplified procedure,” has evolved for evaluating the seismic liquefaction resistance of soils. This procedure has become the standard practice in North America and throughout much of the world. Seed and Idriss (1971) developed and published the basic “simplified procedure.” The procedure has been corrected and augmented periodically since that time with landmark studies by Seed (1979), Seed and Idriss (1982), and Seed et al. (1985).

In 1985, the Committee on Earthquake Engineering of the National Research Council (NRC) organized a workshop with experts from the profession and observers who thoroughly reviewed the state-of-the-art for assessing liquefaction hazard in order to evaluate and update the procedure. The workshop produced a report (NRC, 1985) that has become a widely used reference. Another workshop, held in 1996 and sponsored by MCEER, was convened to review developments and gain consensus for further augmentations to the procedure. The scope of the workshop was limited to evaluation of liquefaction resistance. The workshop proceedings provide further updates to the simplified procedure (see Youd and Idriss, 1997) and various recommendations were made on the following topics:

1. Use of the standard and cone penetration tests for evaluation of liquefaction resistance

Sponsors

MCEER Highway Project
National Science Foundation

Related Highway Project Tasks

- *Effects of Liquefaction on Vulnerability Assessment*, **G. Martin**, University of Southern California and **T.L. Youd**, Brigham Young University
- *Liquefaction Remediation Techniques for Bridge Foundations*, **G. Martin**, University of Southern California and **J. Mitchell**, Virginia Polytechnic Institute
- *Synthesis Report: Liquefaction Vulnerability Assessment*, **G. Martin**, University of Southern California and **T.L. Youd**, Brigham Young University



Workshop Organizers

T.L. Youd, Brigham Young University

I.M. Idriss, University of California, Davis

Workshop Participants

R.D. Andrus, National Institute of Standards and Technology

I. Arango, Bechtel Corp.

G. Castro, GEI Consultants, Inc.

J.T. Christian, Consultant, Boston

R. Dobry, Rensselaer Polytechnic Institute

W.D. Liam Finn, University of British Columbia

L.F. Harder, California Department of Water Resources

M.E. Hynes, U.S. Army Engineers Waterways Experiment Station

K. Ishihara, Science University of Tokyo

J. Koester, U.S. Army Engineers Waterways Experiment Station

S. S.C. Liao, Parsons Brinckerhoff

W. Marcuson III, U.S. Army Engineers Waterways Experiment Station

G. Martin, University of Southern California

J. Mitchell, Virginia Polytechnic Institute

Y. Moriwaki, Woodward Clyde Consultants

M. Power, Geomatrix Consultants, Inc.

P. Robinson, University of Alberta, Edmonton

R. Seed, University of California, Berkeley

K. Stokoe, University of Texas, Austin

2. Use of shear wave velocity measurements for evaluation of liquefaction resistance
3. Use of Becker penetration test for gravelly soils
4. Magnitude scaling factors
5. Correction factors for large overburden pressures

In addition, a "screening guide" for assessing liquefaction hazard was developed by Youd (1998). The guide presents procedures for the systematic evaluation of liquefaction resistance and damage potential for bridge sites and guidance for the prioritization of sites for further investigation and possible remediation. The screening guide procedures are generic, and can be used to determine liquefaction hazard for a variety of other types of structures.

Evaluating Liquefaction Resistance of Soils

In general, soil liquefaction is a major concern for structures constructed on saturated sandy soils. Major earthquakes, such as the 1906 San Francisco, 1964 Alaska, 1964 Niigata, Japan, 1989 Loma Prieta, and 1995 Kobe, Japan, produced extensive damage as a consequence of liquefaction and illustrate the need for engineering procedures to assess and mitigate the hazard. Since 1964, experimental and analytical studies have been carried out to better understand this phenomenon. Much of the early work was based on laboratory testing of reconstituted samples subjected to cyclic loading by means of cyclic triaxial, cyclic simple shear, or cyclic torsional

This research developed unified procedures for the assessment of seismic hazard to highway systems as a consequence of liquefaction, and produced two significant publications. *Proceedings of the NCEER Workshop on Evaluation of Liquefaction Resistance of Soils*, NCEER-97-0022, provides consensus updates to standard procedures that can be used for evaluations of liquefaction susceptibility for a wide array of applications. The consensus approach to liquefaction evaluation is being referenced in many new documents for geotechnical engineers. The approach has recently been recommended by the city and county of Los Angeles, thus it is expected that geotechnical consultants in the Los Angeles area will refer to the updated "simplified procedure" described in these proceedings. The *Screening Guide for Rapid Assessment of Liquefaction Hazard at Highway Bridge Sites*, MCEER-98-0005, is intended for use by highway engineers with experience in geotechnical engineering practice, but not necessarily specialized in seismic hazard evaluation. It is based on well-established experimental and analytical procedures developed in the U.S. and Japan and structured for implementation by practicing engineers. The simplified procedures and the screening guide are not highway specific, i.e., they can be used for generic liquefaction evaluation purposes for a wide variety of structures.

tests. The outcome of these studies generally confirmed the fact that resistance to cyclic loading is influenced primarily by the state of the soil, the intensity and duration of the cyclic loading, and the grain characteristics of the soil. However, the results also showed that the disturbance induced by sampling and test preparation procedures so greatly affected the test results that laboratory procedures were abandoned for routine engineering practice. At that point, the laboratory procedure was replaced by a procedure based on cheaper and generally more reliable field tests, such as standard cone penetration tests, for evaluation of liquefaction resistance.

The calculation or estimation of two primary seismic variables is required to evaluate liquefaction resistance. These variables are the seismic demand placed on a soil layer, expressed in terms of cyclic stress ratio (CSR), and the capacity of a soil layer to resist liquefaction, expressed in terms of cyclic resistance ratio (CRR).

Seed and Idriss (1971) formulated the following equation for calculating CSR:

$$CSR = \left(\tau_{av} / \sigma'_{vo} \right) = 0.65 \left(a_{max} / g \right) \left(\sigma_{vo} / \sigma'_{vo} \right) r_d \quad (1)$$

where a_{max} is the peak horizontal acceleration during an earthquake, g is the gravitational acceleration, σ_{vo} and σ'_{vo} are total and effective overburden stress, respectively; and r_d is a stress reduction factor. Curves showing the range and average values of r_d are plotted in Figure 1. For noncritical projects such as hazard screening, the following equations

may be used to estimate average values of r_d for use in Equation 1:

$$r_d = \begin{cases} 1.0 - 0.00765z & z \leq 9.2\text{m} \\ 1.174 - 0.0267z & 9.2 < z \leq 23\text{m} \\ 0.744 - 0.008z & 23 < z \leq 30\text{m} \\ 0.50 & z > 30\text{m} \end{cases} \quad (2)$$

where z is depth below ground surface in meters. Average values of r_d estimated from these equations are plotted on Figure 1.

Several procedures have been applied to determine CRR. As noted above, field tests have become the state-of-the-practice for routine investigations to avoid the difficulties associated with sampling and testing. Accordingly, as part of the general consensus recommendations from the 1996 workshop (see Youd and Idriss, 1997), four field tests were recommended for general use in evaluating liquefaction resistance for engineering practice. These are: (1) standard penetration test (SPT), (2) cone penetration test (CPT), (3) measurement of shear-wave velocity (V_s), and (4) Becker

Collaborative Partners (cont.)

Co-authors of Papers Presented

- R. Boulanger**, University of California, Davis
- R. Kayen**, U.S. Geological Survey, Menlo Park
- S. Noble**, DOWL Engineers, Anchorage
- R. Olson**, U.S. Army Engineers Waterways Experiment Station
- C. Wride**, University of Alberta, Edmonton

Reviewers of the Workshop Proceedings

- D. Anderson**, CH2M-Hill
- T. Blake**, Fugro-West

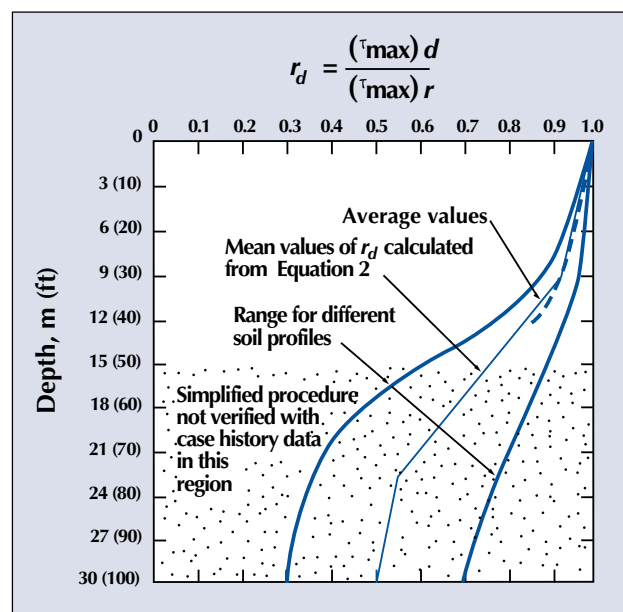

■ Figure 1. r_d versus Depth Curves Developed by Seed and Idriss (1971) with Added Mean Value Lines from Equation 2

penetration test (BPT) for gravelly sites. The advantages and disadvantages of each test are listed in Table 1. A conscientious attempt was made to correlate liquefaction resistance criteria from various tests to provide generally consistent results, no matter which test is employed and independent of the testing conditions. Some recommendations and considerations for each test are briefly discussed in the following.

Standard Penetration Test (SPT)

Criteria for evaluating liquefaction resistance based on SPT blow counts are largely embodied in the CSR versus $(N_1)_{60}$ plot as shown in Figure 2. Conservatively drawn CRR curves separate data indicative of liquefaction from data indicative of nonliquefaction for various fines contents. The CRR curve for magnitude 7.5 earthquakes and for fines contents less than 5% is the basic

penetration criterion for a simplified procedure and is referred to as the “simplified base curve.” A recommended adjustment to this plot was to modify the trajectory of the simplified base curve at low $(N_1)_{60}$ to a projected CRR intercept of about 0.05 as shown in Figure 2. This adjustment reshapes the base curve to achieve consistency with CRR curves developed from cone penetration test (CPT) data and probabilistic analysis by Liao et al. (1988) and Youd and Noble (1997).

Cone Penetration Test (CPT)

Although not as commonly used as the SPT, the CPT is becoming a major tool for delineating soil stratigraphy and for conducting preliminary evaluations of liquefaction resistance. Criteria have been developed for calculating liquefaction resistance (CRR) directly from CPT data (see Robertson and Wride in Youd and Idriss, 1997). These criteria may be applied in practice—provided adequate samples are retrieved, preferably by the SPT procedure—to verify the soil types and liquefaction resistance assigned.

Figure 3 shows the primary chart used for determining liquefaction resistance from CPT data for clean sands. The chart shows CSR plotted against corrected and normalized CPT resistance, q_{cIN} , from sites where liquefaction was or was not observed following past earthquakes. Similarly, a CRR curve defines the boundary between liquefaction and nonliquefaction. This chart is valid for magnitude 7.5 earthquakes and clean, sandy soil. The figure also shows that cyclic shear strain and ground deformation potential at liquefiable sites decrease as penetration resistance increases (dashed curves).

■ Table 1. Comparison of Advantages and Disadvantages of Various Field Tests

Feature	Test Type			
	CPT	SPT	V_s	BPT
Number of test measurements at liquefaction sites	Abundant	Abundant	Limited	Sparse
Type of stress-strain behavior influencing test	Drained, large strain	Partially drained, large strain	Small strain	Partially drained, large strain
Quality control and repeatability	Very good	Poor to good	Good	Poor
Detection of variability of soil deposits	Very good	Good	Fair	Fair
Soil types in which test is recommended	Non-gravel	Non-gravel	All	Primarily gravel
Test provides sample of soil	No	Yes	No	No
Test measures index or engineering property	Index	Index	Engineering property	Index

Because the CPT equipment and procedures are less variable than those for the SPT, fewer corrections are required. Nevertheless, corrections are still required for overburden pressure and grain characteristics. These corrections are discussed in detail in papers by Robertson and Wride, and Olsen, in Youd and Idriss (1997).

Finally, theoretical as well as laboratory studies indicated that cone resistance is influenced by softer or stiffer soil layers above or below the cone tip. It was observed that the CPT did not usually measure the full penetration resistance in thin sand layers sandwiched between layers of softer soils. Based on an elastic solution, Vreugdenhil et al. (1994) developed a procedure for estimating full cone penetration resistance of thin, stiff layers contained within softer strata. Robertson and Fear (1995) further suggested a correction factor for cone resistance, K_H , as a function of layer thickness as shown in Figure 4.

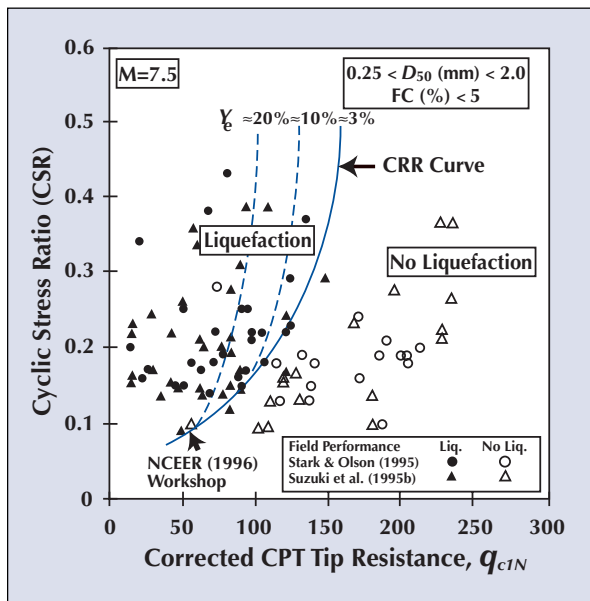

■ Figure 3. Recommendations for Calculating CRR and CPT Data Along with Empirical Liquefaction Data (after Youd and Idriss, 1997)

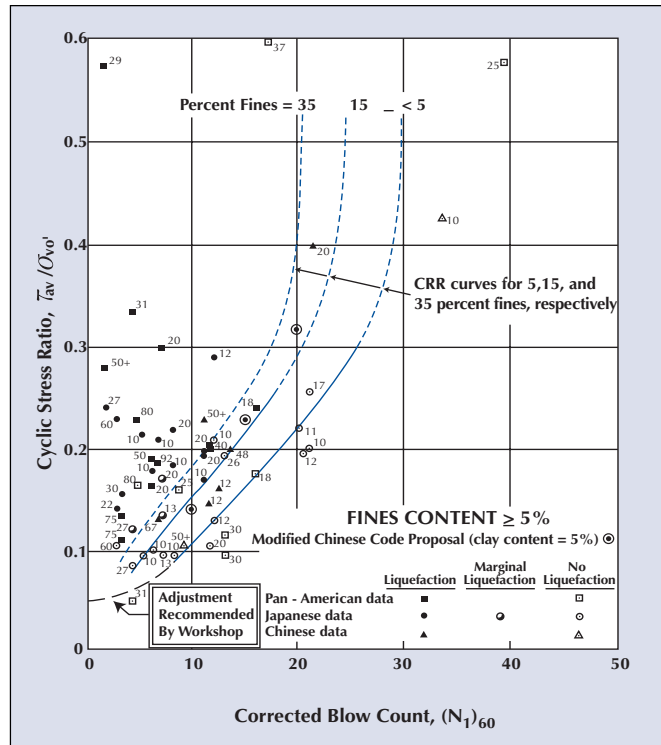

■ Figure 2. Simplified Base Curve Recommended for Calculating CRR from SPT Data Along with Empirical Liquefaction Data (after Youd and Idriss, 1997)

Shear Wave Velocity, V_s

Several simplified procedures have been proposed for the use of field measurements of small-strain shear wave velocity, V_s , to assess liquefaction resistance of granular soils. The advantages of using V_s are that (1) it can be accurately measured in-situ using a number of techniques such as crosshole and downhole seismic tests, the seismic cone penetration test, or spectral analysis of surface waves, (2) measurements are possible in soils that are difficult to penetrate with CPT and SPT, (3) measurements can be performed in small laboratory

specimens allowing direct comparison between laboratory and field behavior, and (4) it is directly related to small-strain shear modulus. Two significant limitations of using V_s in liquefaction hazard evaluations are that seismic wave velocity measurements are made at small strains whereas liquefaction is a large strain phenomenon, and seismic testing does not provide samples for classification of soils and identification of nonliquefiable soft clay-rich soils. A paper by Andrus and Stokoe (Youd and Idriss, 1997) reviews current simplified procedures for evaluating the liquefaction resistance of granular soil deposits using small-strain shear wave velocity.

Becker Penetration Tests (BPT)

Liquefaction resistance of non-gravelly soils has been evaluated primarily through CPT, SPT and occasionally with V_s measurements. However, CPT and SPT are not generally reliable in gravelly soils as large gravel particles may interfere with the normal deformation of soil materials around the penetrometer, increasing penetration resistance. Therefore, the Becker penetration

test (BPT) has become an effective tool using large-diameter penetrometers. The BPT consists of a 3 m long double-walled casing driven into the ground with a double-acting diesel-driven pile hammer. The BPT resistance is defined as the number of blows required to drive the casing through an increment of 300 mm.

The BPT is not correlated directly with liquefaction resistance, but is used to estimate equivalent SPT blow counts through empirical correlations. The equivalent SPT blow count is then used to estimate liquefaction resistance. However, studies have shown that SPT blow counts can only be roughly estimated from BPT measurement due to deviations in hammer energy for which Harder and Seed (1986) developed an energy correction procedure based on measured bounce-chamber pressure, and friction along the driven casing and its influence on the penetration resistance.

Workshop Conclusions

In addition to discussing the various tests described above, workshop participants examined magnitude scaling factors; corrections for high

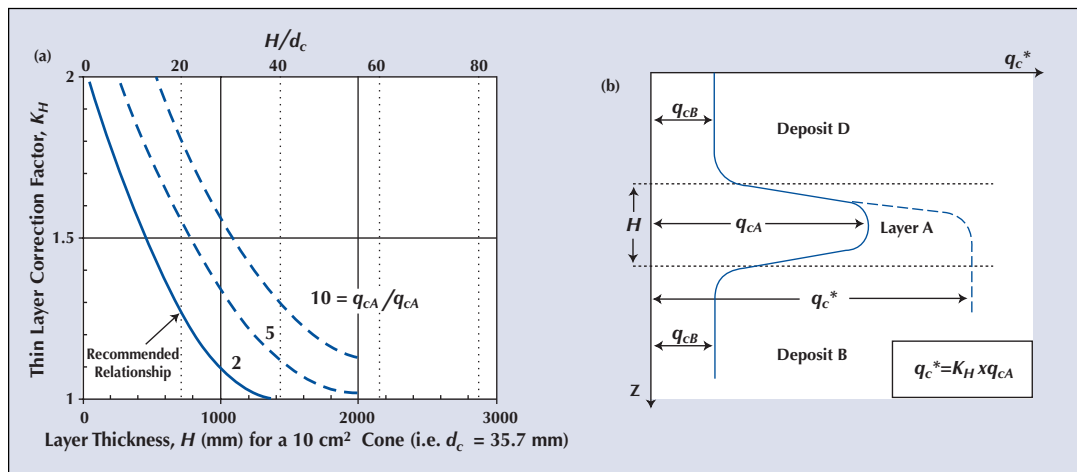

■ Figure 4. Thin-layer Correction Factor, K_H , for Determination of Equivalent Thickness-layer CPT Resistance (modified from Robertson and Fear, 1995)

overburden pressures, static shear stresses and age of deposit; seismic factors, such as magnitude and peak acceleration; and energy-based criteria and probabilistic analyses. General consensus recommendations included the following (see Youd and Idriss, 1997):

- Consensus criteria for evaluating liquefaction resistance were developed for SPT, CPT, shear wave velocity and BPT tests.
- Two or more test procedures should be applied at each site to assure both adequate definition of soil stratigraphy and consistent evaluation of liquefaction resistance is attained.
- New sets of magnitude scaling factors are recommended for engineering practice. These factors are greater than those used previously for earthquakes with magnitude less than 7.5. The new factors yield safe but less conservative estimates of liquefaction resistance.
- Evaluating liquefaction resistance beneath sloping ground or embankments is not well understood at this time.
- Moment magnitude, M_w , should be used as an estimate of earthquake size for liquefaction resistance calculations.
- The preferred procedure for estimating peak acceleration is to apply attenuation relationships consistent with soil conditions at a given site.

Developing a Screening Guide

Liquefaction does not occur randomly in natural deposits but is limited to a rather narrow range of seismic, geologic, hydrologic, and soil

environments. Taking advantage of relationships between these environments and liquefaction susceptibility, a screening guide was developed which guides geotechnical engineers in conducting rapid assessments of liquefaction hazard. The guide presents a systematic application of standard criteria for assessing liquefaction susceptibility, evaluating ground displacement potential, and assessing the vulnerability of bridges to liquefaction-induced damage. The screening proceeds from least complex, time-consuming and data-intensive evaluations to the more complex, time-consuming, and rigorous analyses. Thus, many bridge sites can be evaluated and classified as low hazard with very little time and effort. Only bridge sites with significant hazard need to be evaluated with the more sophisticated and time-consuming procedures.

The screening guide is conservative—that is, at each juncture in the screening process, uncertainty is weighed on the side that liquefaction and ground failure could occur. Thus, a conclusion that liquefaction and detrimental ground displacement are very unlikely is a much more certain conclusion than the converse outcome—that liquefaction and detrimental ground displacements are possible. This conservatism leads to the corollary conclusion that additional investigation is more likely to reduce the estimated liquefaction hazard than increase it.

The principal steps and logic path for the screening procedure are listed in Figure 5. In assessing liquefaction hazard, the recommended procedure is to start at the top of the logic path, perform the required analyses for each step, and

“The simplified procedures and the screening guide are not highway specific, i.e., they can be used for generic liquefaction evaluation purposes for a wide variety of structures.”

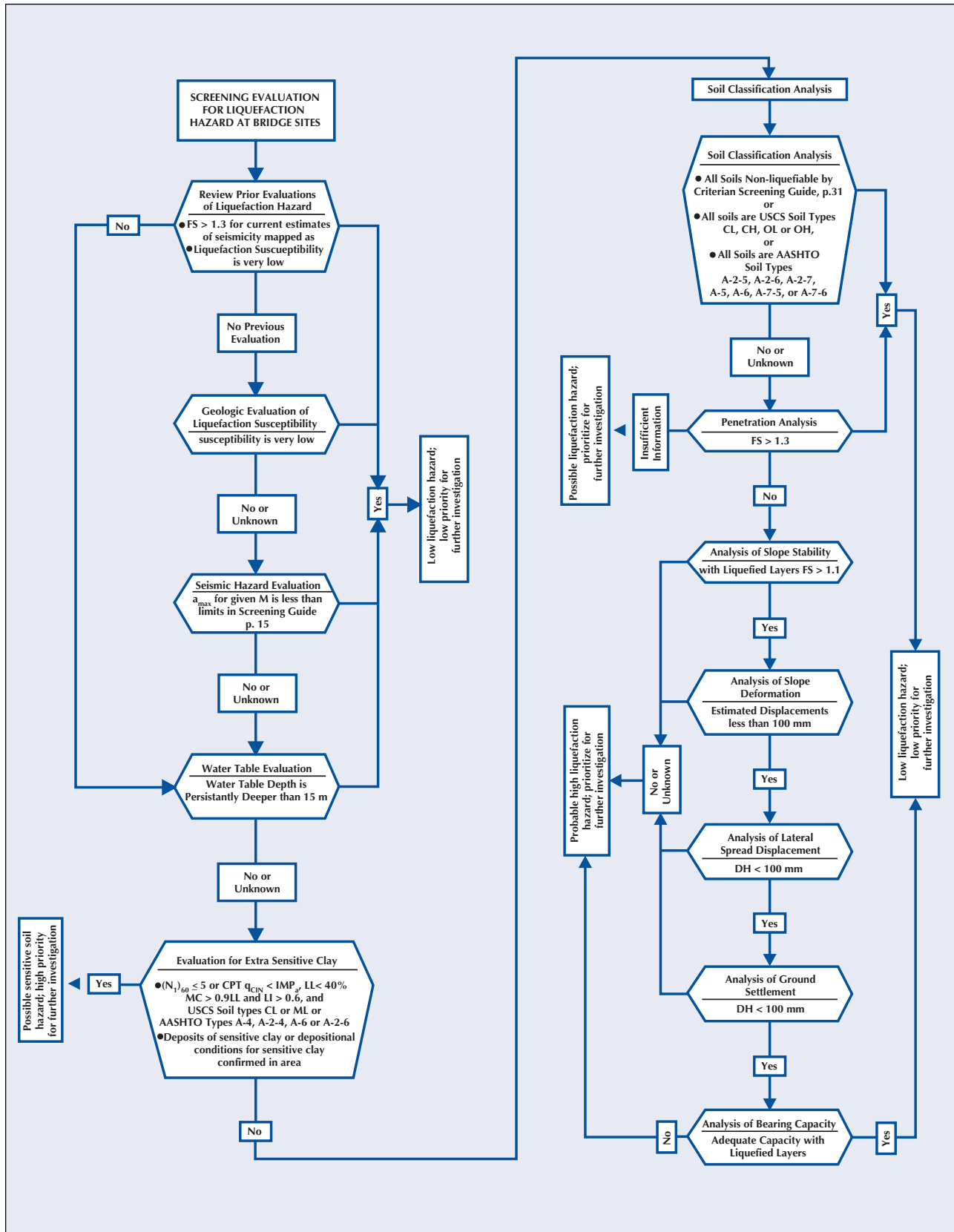

■ Figure 5. Flow Diagram Showing Steps and Criteria for Screening of Liquefaction Hazard for Highway Bridges

proceed downward until the bridge is classified into one of four categories:

1. Confirmed high liquefaction and ground failure hazard—very high priority for further investigation and possible mitigation;
2. Confirmed liquefaction susceptibility but unknown ground failure hazard—high priority for further investigation;
3. Insufficient information to assess liquefaction susceptibility—prioritized for further investigation;
4. Low liquefaction hazard—low priority for further investigation.

If there is clear evidence that liquefaction or damaging ground displacements are very unlikely, the site is classed as “low liquefaction hazard and low priority for further investigation,” and the evaluation is complete for that site. If the available information indicates a likely hazard, or if the data are inadequate or incomplete, the site is classed as having possible liquefaction hazard, and the screening proceeds to the next step. If the available site information is insufficient to complete a liquefaction hazard analysis, then simplified seismic, topographic, geologic, and hydrologic criteria are used to prioritize the site for further investigation. The complete details of the procedure are given by Youd (1998).

Conclusions and Recommendations for Future Research

The consensus approach to liquefaction evaluation is being referenced in many new documents for geotechnical engineers throughout

the U.S. The updated “simplified procedure” has been recommended in both the city and county of Los Angeles as the preferred approach to use to assess liquefaction potential at a given site. In a companion effort, liquefaction hazard maps have been produced for southern California and the California Division of Mines and Geology will produce similar maps for northern California. Taken together, the updated maps and the updated “simplified procedure” will greatly enhance the accuracy of liquefaction hazard assessments. Accurate assessments will allow retrofit projects to be prioritized according to potential impact and new projects to be designed to accommodate potential hazards.

Finally, there are issues that should be further investigated and addressed in the liquefaction evaluation procedures. The evaluation of liquefaction resistance beneath sloping ground or embankments (slopes greater than 6%) is not well understood. Hence, such evaluations are beyond the applicability of the simplified procedure, and further studies are required to develop procedures for the evaluation of liquefaction resistance beneath sloping ground. Moreover, it is known that liquefaction resistance increases with soil plasticity. However, more research is needed in order to quantify this relationship. Recently, probabilistic methods have been used in some risk analyses, but are still outside the mainstream of standard practice. Similarly, seismic energy passing through a liquefiable layer can be potentially adopted as a liquefaction resistance criteria. This concept is relatively new and also requires further research.

“The updated ‘simplified procedure’ has been recommended in both the city and county of Los Angeles as the preferred approach to use to assess liquefaction potential at a given site.”

References

- Kachadoorian, R., (1968), *Effects of the Earthquake of March 27, 1964, on the Alaska Highway System*, U.S. Geological Survey, Professional Paper 545-C.
- Liao, S.S.C., Veneziano, D., Whitman, R.V., 1988, "Regression Models for Evaluating Liquefaction Probability," *Journal of Geotechnical Engineering*, Vol. 114, No. 4, pp. 389-411.
- McCulloch, D.S. and Bonilla, M.G., (1970), *Effects of the Earthquake of March, 1964, on the Alaska Railroad*, U.S. Geological Survey, Professional Paper 545-D.
- National Research Council (NRC), (1985), *Liquefaction of Soils During Earthquakes*, National Academy Press, Washington, D.C.
- Robertson, P.K. and Fear, C.E., (1995), "Liquefaction of Sands and Its Evaluation," *Proceedings of the First International Conference on Earthquake Geotechnical Engineering*, Keynote Lecture, Tokyo, Japan.
- Seed, H.B., (1979), "Soil Liquefaction and Cyclic Mobility Evaluation for Level Ground During Earthquakes," *Journal of Geotechnical Engineering*, ASCE, Vol. 105, No. GT2, pp. 201-255.
- Seed, H.B. and Idriss, I.M., (1971), "Simplified Procedure for Evaluation Soil Liquefaction Potential," *Journal of the Soil Mechanics and Foundation Division*, ASCE, Vol. 97, No. SM9, pp. 1249-1273.
- Seed, H.B. and Idriss, I.M., (1982), *Ground Motions and Soil Liquefaction During Earthquakes*, Earthquake Engineering Research Institute Monograph.
- Seed, H.B., Tokimatsu, K., Harder, L.F. and Chung, R.M., (1985), "The Influence of SPT Procedures in Soil Liquefaction Resistance Evaluations," *Journal of Geotechnical Engineering*, ASCE, Vol. 111, No. 12, pp. 1425-1445.
- Vreugdenhil, R., Davis, R. and Berrill, J., (1994), "Interpretation of Cone Penetration Results in Multilayered Soils," *International Journal for Numerical Methods in Geomechanics*, Vol. 18, pp. 585-599.
- Youd, T.L., (1993), *Liquefaction-Induced Damage to Bridges*, Transportation Research Record, No. 1411, pp. 35-41.
- Youd, T.L., (1998), *Screening Guide for Rapid Assessment of Liquefaction Hazard at Highway Bridge Sites*, Technical Report MCEER-98-0005, Multidisciplinary Center for Earthquake Engineering Research, Buffalo New York.
- Youd, T.L. and Idriss, I.M., eds, (1997), *Proceedings of the NCEER Workshop on Evaluation of Liquefaction Resistance of Soils*, Technical Report NCEER-97-0022, Multidisciplinary Center for Earthquake Engineering Research, Buffalo, New York.
- Youd, T.L. and Noble, S.K., (1997), "Liquefaction Criteria Based on Statistical and Probabilistic Analyses," *Proceedings of the NCEER Workshop on Evaluation of Liquefaction Resistance of Soils*, Technical Report NCEER-97-0022, Multidisciplinary Center for Earthquake Engineering Research, Buffalo, New York.

Fragility Curve Development for Assessing the Seismic Vulnerability of Highway Bridges

by John B. Mander,
University at Buffalo, State University of New York

Research Objectives

The principal objective of this research is to develop, from the fundamentals of mechanics and dynamics, the theoretical basis of establishing *fragility curves* for highway bridges through the use of rapid analysis procedures. In contrast to other methods that have been used in the past, such as either empirical/experiential fragility curves or individualized fragility curves based on extensive computational simulations, the present approach seeks to establish dependable fragility curves based on the limited data readily obtainable from the National Bridge Inventory (NBI).

The purpose of this research is to set forth the basis for developing *fragility curves* that can be used in various ways as part of a seismic vulnerability analysis methodology for highway bridges.

To develop a set of fragility curves for various damage states for a specific bridge, the notion of adjusting “Standard Bridge” fragility curves for site-specific effects is adopted. Only three sources of data are needed for this analysis: (1) National Bridge Inventory (NBI) records that contain the bridge attributes and geographical location; (2) ground motion data (this is best obtained from the USGS web site); and (3) geological maps from which soil types and hence S-factors can be inferred. Full details of this approach are given in Basöz and Mander (1999).

Sponsors

MCEER Highway Project
National Institute of
Building Sciences (NIBS)

Collaborative Partners

Retrofitting Manual
Ian Buckle, University of
Auckland

Anindya Dutta, EQE
International, formerly of
the University at Buffalo

Gokban Pekcan, University
at Buffalo

Andrei Reinborn, University
at Buffalo

Stuart Werner, Seismic
Systems and Engineering
Consultants

HAZUS Developments
Nesrin Basöz, K2 Technolo-
gies

Michael O'Rourke,
Rensselaer Polytechnic
Institute

**Retrofitting Manual for
Highway Systems**

- *Volume I is concerned with network analysis and requires the use of bridge specific fragility curves to assess the direct and indirect losses as a result of earthquake-induced damage to bridges (Werner et al., 1998; 1999). It is important that a rapid analysis procedure is available to minimize the computational effort and data collection requirements.*
- *Volume II is concerned with the seismic evaluation and retrofitting measures for bridge structures. In order to assess the seismic vulnerability of a suite of bridges, “rapid screening” techniques are used. As an alternative to using indexing methods, similar to the multiplicity of existing approaches used currently by various states and the present retrofitting manual, the proposed fragility curve based method for the rapid screening of highway bridges is consistent with the network analysis used in Volume I and the detailed analysis of Volume II.*
- *The underlying theory that forms the basis of the fragility curve development for these applications is also the same as that used in the detailed analysis of bridge structures and the seismic performance of individual components and members. These detailed procedures are described in Volume II.*

The Approach Using “Standard Bridge” Fragility Curves

Fragility Curve Theory

For a given bridge, it is possible to predict, deterministically, the level of ground shaking necessary to achieve a target level of response and/or damage state. In addition to assuming material properties and certain other structural attributes that affect the overall *capacity* of a bridge, such a deterministic assessment requires that certain assumptions be made about the ground motion and site conditions—both factors that affect seismic *demand*. Naturally, values of these parameters are not exact—they invariably have a measure of both randomness and uncertainty associated with them. An increasingly popular way

of characterizing the probabilistic nature of the phenomena concerned is through the use of so-called *fragility curves*. Figure 1 shows how the inherent uncertainty and randomness of bridge capacity versus ground motion demand can be used to establish fragility curves. Figure 1(a) shows an acceleration-displacement spectra for the ground motion. Superimposed with this curve is the push-over capacity of a bridge. In a deterministic analysis, the intersection of the two curves gives the expected level of performance. However, probability distributions are drawn over both the capacity and demand curves to indicate the associated uncertainty and randomness of performance. From this figure it is evident there is a wide range of possible performance outcomes—there is not a unique or exact answer.

It is anticipated that planning engineers in State and Federal government may use network analysis software that has been developed as part of Volume I of a three-volume set of Retrofitting Manuals under the MCEER Highway Project (see *Seismic Retrofitting Manual for Highway Systems* in this report). This software will contain fragility curves for bridges developed as part of this research.

Bridge engineers in State departments of transportation use “rapid screening” techniques for assessing the seismic vulnerability of bridges as a planning/scheduling tool. The new approach is expected to use the fragility curve methodology developed herein.

Engineers, social scientists and planners use the FEMA-NIBS software HAZUS, which is to contain a new fragility curve procedure developed as part of this research.

State departments of transportation and their engineering consultants are expected to use detailed seismic evaluation procedures as part of their retrofitting design studies. The underlying theory that forms the basis of the fragility curve development is also the same as that used in the detailed analysis of bridge structures and the seismic performance of individual components and members.

If structural capacity and seismic demand are random variables that roughly conform to either a normal or log-normal distribution then, following the *central limit theorem*, it can be shown that the composite performance outcome will be log-normally distributed. Therefore, the probabilistic distribution is expressed in the form of a so-called fragility curve given by a log-normal cumulative probability density function. Fortunately, only two parameters are needed to define such a curve—a median (the 50th percentile) and a normalized logarithmic standard deviation. Figure 1(b) presents the form of a normalized fragility curve for bridges. The cumulative probability function is given by:

$$F(S_a) = \Phi \left[\frac{1}{\beta_c} \ln \left(\frac{S_a}{A_i} \right) \right] \quad (1)$$

where Φ is the standard log-normal cumulative distribution function; S_a is the spectral acceleration amplitude (for a period of $T = 1$ sec.); A_i is the *median* (or expected value) spectral acceleration necessary to cause the i^{th} damage state to occur; and β_c is the normalized composite log-normal standard deviation which incorporates aspects of uncertainty and randomness for both capacity and demand. The latter parameter is sometimes loosely referred to as either the coefficient of variation or the coefficient of dispersion. The parameter has been calibrated by Pekcan (1998), Dutta and Mander (1998) and Dutta (1999) from a theoretical perspective, and validated by Basöz and Mander (1999) against experiential fragility curves obtained from data gathered from the 1994 Northridge and 1989 Loma Prieta earthquakes by Basöz and Kiremidjian (1998).

Based on these investigations it is recommended that $\beta_c = 0.6$.

Median values of the peak ground acceleration for five different damage states are assessed using an algorithm that is based on the so-called *capacity-spectrum* method, as indicated in Figure 1(a). This displacement-based nonlinear static analysis procedure assumes a standard AASHTO-like earthquake response spectrum shape, which can be adjusted later to account for site-specific spectral ordinates and/or soil types. The five damage states and their associated performance outcomes are listed in Table 1.

Links to Current Research (cont.)

HAZUS Developments

- The HAZUS project, which is sponsored by FEMA through a contract with NIBS, is using the results of this research to develop software for the second-generation of fragility curves for highway bridges. This is part of the first major revision of HAZUS and is included in the HAZUS98 software (refer also to HAZUS, 1997).

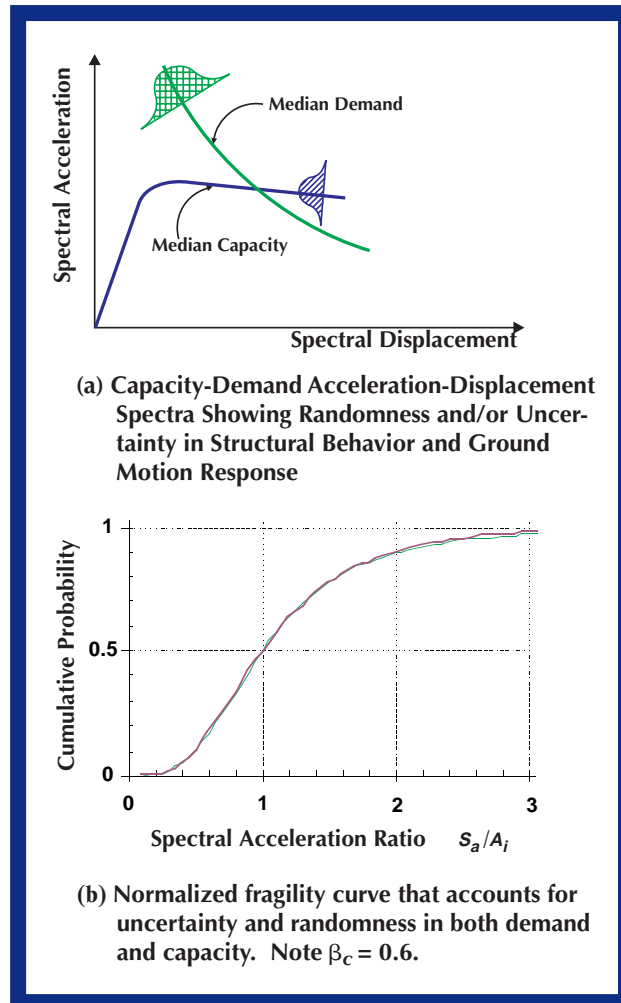

■ Figure 1. Probabilistic Definition of Uncertainty/Randomness in Establishing Fragility Curves for a Seismic Vulnerability Analysis

■ **Table 1.** Definition of Damage States and Performance Outcomes

Damage State	Descriptor for Degree of Damage	Post-earthquake Utility of Structure	Repairs Required	Time of Outage Expected
1	None (pre-yield)	Normal	None	--
2	Minor/Slight	Slight damage	Inspect, adjust, patching	<3 days
3	Moderate	Repairable damage	Repair components	<3 weeks
4	Major/Extensive	Irrepairable damage	Rebuild components	<3 months
5	Complete/Collapse	Irrepairable damage	Rebuild structure	>3months

■ **Table 2.** Fields in NBI used in Determining Bridge Fragility

NBI Data Item	Definition	K_{skew}	K_{3D}	Other Use
1	State		*	To infer type of code design
8	Structure number			General identification number
27	Year built		*	Infers whether seismic or conventional design
34	Skew	*		
42	Service type			To select highway bridges
43	Structure type		*	To infer base fragility curve from Table 3
45	Number of spans in main unit		*	To infer whether single or multiple span
46	Number of approach spans			To infer whether bridge is a major bridge
48	Length of maximum span		*	To infer whether bridge is a major bridge (major bridge if $L > 150$ m)
49	Structure length		*	To infer average span length; to compute replacement value
52	Deck width			To compute replacement value

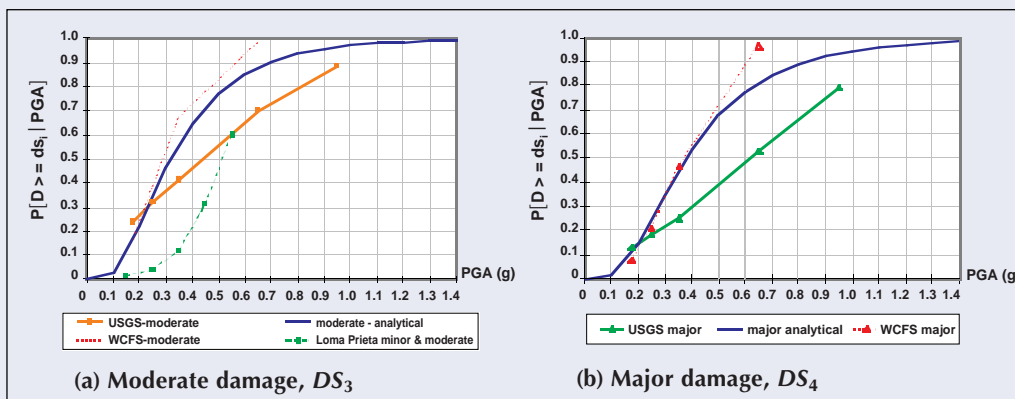

■ **Figure 2.** Comparison of Analytical and Empirical Fragility Curves for Discontinuous Multiple Span Bridges with Single Column Bents and Non-monolithic Abutments

Validation of Theory with Empirical Evidence

Analytically predicted fragility curves for various different bridge types were validated against fragility curves that were empirically derived from data gathered for highway bridges damaged in the 1994 Northridge and 1989 Loma Prieta earthquakes. A sample of the validation for one common class of California bridge is given in Figure 2. In spite of the large degree of uncertainty in defining both bridge damage and the spatial distribution of ground motion in the field, it will be noted that both the median damage values (50 percentile) and the shape (for $\beta_c = 0.6$) of the fragility curves agree rather well.

Implementation and Database Requirements

The National Bridge Inventory (NBI) is a database maintained by the Federal Highway Administration that contains information on every highway bridge in the U.S. The database has 116 fields that are used to describe structural and operational characteristics of a bridge. Because all the nation's highway bridges are required to be inspected on a biennial basis, the NBI database is kept up to date. Information in the NBI provides functional and operational characteristics, but there is insufficient detail to permit a detailed analysis to be performed when deriving fragility curves. Therefore, the basis of obtaining a bridge specific fragility curve is to take the results of a "standard bridge" fragility curve and to scale those results using selected data from the NBI.

A "standard bridge" is assumed to be a "long" structure with no appreciable three-dimensional (3D) effects present. For several types of "standard bridges," median PGA values have been derived for each of the damage states (a_2, a_3, a_4, a_5). The results of the "standard bridge" are then modified by factors accounting for skew (K_{skew}) and 3D effects (K_{3D}) using the NBI database described in Table 2. This table shows which fields of the NBI are used and for what purpose.

"Standard Bridge" Fragility Curves

The "standard bridge" fragility curves are presented in Table 3 where median fragility parameters are listed for conventionally (non-seismically) designed and seismically designed bridges. Implicit in the median fragility curve values are assumptions which are considered to be in keeping with typical construction practice throughout the U.S.

Scaling the "Standard Bridge" Fragility Curves to Account for Skew and 3D Effects

In order to convert the "standard bridge" fragility curves to a bridge-specific value for a given spectral acceleration, the parameters K_{skew} and K_{3D} are used as *scaling relations*. The effect of bridge skew on changing fragility curves can be accounted for by applying the angle of skew given in the NBI (α_{skew}) using:

$$K_{skew} = \sqrt{\sin \alpha_{skew}} \quad (2)$$

Related Highway Project Tasks

- *Structure Fragility - Examination and Upgrading of ATC-13, A. Cakmak, Princeton University*
- *Lateral Strength Analysis Methods, R. Imbsen, Imbsen Associates, Inc.*
- *Risk Assessment of Highway Systems, S. Werner, Seismic Systems and Engineering Consultants*
- *Seismic Risk Analysis of Bridges in Memphis, H. Hwang, Center for Earthquake Research and Information, University of Memphis*
- *Evaluation of Bridge Damage Data from Recent Earthquakes, A. Kiremidjian, Stanford University*
- *SRA Validation and Fragility Curves, M. Shinozuka, University of Southern California and G. Deodatis, Princeton University*
- *Major Bridge Damage State Modeling, W.D. Liu, Imbsen Associates, Inc.*

■ Table 3. U.S. Highway Bridge Fragility Curve Median Values of PGA

Classification	NBI Class	Damage State	Median PGA		
			Conventionally Designed Bridges		Seismically Designed
			Non-California	California	
Multi-column bents, simply-supported	101-106 301-306 501-506	2	0.26	0.33	0.45
		3	0.35	0.46	0.76
		4	0.44	0.56	1.05
		5	0.65	0.83	1.53
Single column bents, box girders, discontinuous	205-206 605-606	2	not applicable	0.35	0.54
		3		0.42	0.88
		4		0.50	1.22
		5		0.74	1.45
Continuous concrete	201-206 601-607	2	0.60*	0.60*	0.91*
		3	0.79	0.79	0.91
		4	1.05	1.05	1.05
		5	1.38	1.38	1.38
Continuous steel	402-410	2	0.76*	0.76*	0.91*
		3	0.76	0.76	0.91
		4	0.76	0.76	1.05
		5	1.04	1.04	1.38
Single span	All	2	0.8*	0.8*	0.8*
		3	0.9	0.9	0.9
		4	1.1	1.1	1.1
		5	1.6	1.6	1.6
Major bridges		2	0.4	0.4	0.6
		3	0.5	0.5	0.8
		4	0.6	0.6	1.0
		5	0.8	0.8	1.6

* Short period portion of spectra applies, therefore evaluate K_{shape} .

■ Table 4. Modification Rules Used to Model 3D Effects

Type	NBI Class	K_{3D} Conventional Design	K_{3D} Seismic Design Year > 1990 (> 1975 in CA)
Concrete	101-106	$1 + 0.25/n_p$	$1 + 0.25/n_p$
Concrete Continuous	201-206	$1 + 0.33/n$	$1 + 0.33/n_p$
Steel	301-310	$1 + 0.09/n_p$; $L \geq 20$ m $1 + 0.20/n_p$; $L < 20$ m	$1 + 0.25/n_p$
Steel Continuous	402-410	$1 + 0.05/n$; $L \geq 20$ m $1 + 0.10/n$; $L < 20$ m	$1 + 0.33/n_p$
Prestressed Concrete	501-506	$1 + 0.25/n_p$	$1 + 0.25/n_p$
Prestressed Concrete Continuous	601-607	$1 + 0.33/n$	$1 + 0.33/n_p$

n = number of spans in bridge; $n_p = n - 1$ = number of piers

Table 4 presents modification rules to account for 3D effects via the parameter K_{3D} . This parameter converts a long “standard bridge” structure to a specific (straight/right) bridge with a finite number of spans.

Scaling Relations for Damage States 3, 4, and 5

The modified median fragility curve parameter is given by

$$A_i = K_{skew} K_{3D} a_i / S \quad (3)$$

where a_i is the median spectral acceleration (for $T = 1.0$ second spectral ordinate) for the i^{th} damage state listed in Table 3; S is the soil amplification factor for the long period range, that is the 1.0 second period amplification factor, F_v , given by NEHRP (note $S = 1$ for rock sites was assumed in deriving the “standard bridge” fragility curves).

Scaling Relations for Damage State 2

For slight damage, the median fragility curve parameter is given by the following equation:

$$A_2 = K_{shape} a_2 / S \quad (4)$$

where a_2 is the PGA level given in table 3; S is the soil amplification factor; and K_{shape} is defined by the following equation:

$$K_{shape} = 2.5 C_v / C_a \quad (5)$$

In Equation (5), the factor 2.5 is the ratio between the spectral amplitude at 1.0 second (C_a) and 0.3 seconds (C_v) for the standard code-based spectral shape for which the

■ Table 5. Modified Repair Cost Ratio for All Bridges

Damage State	Best Mean Repair Cost Ratio	Range of Repair Cost Ratios
1: No damage (pre-yield)	0	0
2: Slight damage	0.03	0.01 to 0.03
3: Moderate damage	0.08	0.02 to 0.15
4: Extensive damage	0.25	0.10 to 0.40
5: Complete	See Equation 6	0.30 to 1.0

“standard bridge” fragility curves were derived. This equation is necessary to ensure all fragility curves possess a common format—either PGA or S_a at $T = 1.0$ second. Note that where the PGA level given in Table 3 is identified *with* an *, the short period motion governs, $K_{shape} \leq 1$, and the soil amplification factor for “short” period structures (provided by NEHRP) is used. Otherwise, $K_{shape} = 1$.

Note that in Equation (4) there is no modification assumed for skew and 3D effects. The structural displacements that occur for this damage state are assumed to be small (generally less than 50 mm), thus the 3D arching effect is not engaged since the deck joint gaps do not close.

Direct Economic Losses

Based on the work of Mander and Basöz (1999), the damage ratios listed in Table 5 can be used to estimate the extent of damage expected as a result of an earthquake. The best mean repair cost ratio for “complete” damage—that is $RCR_{i=5}$ for damage state 5—is defined as a function of number of spans as given below:

$$RCR_{i=5} = 2/n; \quad \leq 1.0 \quad (6)$$

where n is the number of spans in the main portion of the bridge. In this equation, it is assumed that the most common failure mechanism will result in unseating of, at most, two spans simultaneously.

The total repair cost ratio—that is the expected proportion of the total replacement cost of the entire bridge resulting from earthquake damage, or the *direct loss probability*—is defined as follows:

$$RCR_r = \sum_{i=2}^5 (RCR_i \cdot P[DS_i | S_a]) < 1.0 \quad (7)$$

where $P[DS_i | S_a]$ is the probability of being in damage state DS_i for a given spectral acceleration, S_a , for a structural period of $T = 1.0$

seconds; and RCR_i is the repair cost ratio for the i^{th} damage mode. If this total repair cost ratio is multiplied by the replacement cost of the

bridge, the expected direct monetary dollar loss can be assessed. Work on this aspect is ongoing.

Illustrative Example Problem

Consider a three-span simply supported prestressed concrete bridge located in the Memphis area on very dense soil and soft rock (site class C). Table 6 lists the data for this bridge obtained from NBI. The following ground motion data is assumed for a scenario earthquake: $S_a(T = 0.3 \text{ sec}) = 1.4 \text{ g}$, ($S = 1.0$); $S_a(T = 1.0 \text{ sec}) = 0.28 \text{ g}$, ($S = 1.52$); and $A = 0.35 \text{ g}$.

■ Table 6. Bridge Data Necessary for the Example Analysis

NBI Field	Data	Remarks
27	1968	Year built
34	58	Angle of skew
43	501	Prestressed concrete, simple span
45	3	Number of spans
48	23	Maximum span length (m)
49	56	Total bridge length (m)
52	10	Bridge width (m)

Solution

Since the bridge was constructed in 1968 and is located outside of California, the first and the fifth rows of Table 3 apply, respectively, thus for type 501: $a_2 = 0.26 \text{ g}$; $a_3 = 0.35 \text{ g}$; $a_4 = 0.44 \text{ g}$; and $a_5 = 0.65 \text{ g}$. Note that no * is used for a_2 ; this implies “long periods” always govern, therefore $K_{shape} = 1$.

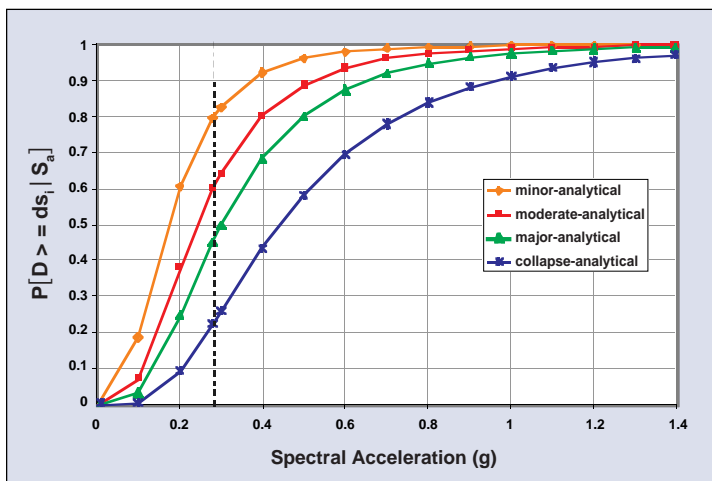

■ Figure 3. Fragility Curves for the Example Prestressed Concrete Bridge with Simply Supported Girders

$$K_{3D} = 1 + \frac{0.25}{n-1} = 1 + \frac{0.25}{3-1} = 1.125;$$

$$K_{skew} = \sqrt{\sin \alpha} = \sqrt{\sin 58} = 0.92 \quad (8)$$

From Equation (4) $A_2 = 0.17$, and Equation (3) $A_i = 0.681a_i$, thus: $A_3 = 0.24 \text{ g}$; $A_4 = 0.30 \text{ g}$; and $A_5 = 0.44 \text{ g}$.

As shown in Figure 3, the probability of being in a given damage state, when $S_a(T = 1 \text{ sec}) = 0.28 \text{ g}$, is given in Table 7. This table also presents the repair cost ratios from which the expected loss ratios are determined in terms of the total

■ Table 7. Analysis of Direct Loss Probability

<i>i</i> (1)	$P[D > DS_i S_a]$ (2)	$P[DS_i S_a]$ (3)	RCR_i (4)	Product (3) X (4)
1	1	0.203	0.00	0.00000
2	0.797	0.196	0.03	0.00588
3	0.601	0.147	0.08	0.01176
4	0.454	0.228	0.25	0.05700
5	0.226	0.226	0.67	0.15142
Total probabilities:		1.000	$RCR_T =$	0.226

replacement cost for the entire bridge. From Table 7, the total loss ratio is $RCR_T = 0.226$.

Conclusions and Future Work

Previous editions of the seismic retrofitting manual have used an indexing method as part of the screening approach. Indeed there are many such methods available that have been used by various state/owner agencies. The method presented herein, however, is a new development. It is the same method that is used in Volume I of the new Manual that is concerned with the post-earthquake integrity of an entire highway system. The method has also been adopted as the future approach for defining fragility curves in HAZUS. The fragility curve-based rapid screening method is consistent with the detailed seismic evaluation approach adopted as it is derived from the same theoretical basis that is founded upon the fundamentals of

mechanics. However, where the rapid screening and detailed approaches differ is in the extent of data gathering, and time and effort necessary to perform a seismic vulnerability analysis. The rapid screening approach operates on limited data as it is intended for evaluating a suite of bridges and ranking them in order of seismic vulnerability. On the other hand, a detailed analysis is intended to be a more exacting assessment of individual bridges and the vulnerability of individual components.

In the future, it is intended to extend the loss estimation ratios to include direct and indirect losses in dollar terms. Direct losses arise from damage to the bridge structure itself, whereas indirect losses may arise as a result of collapse resulting in the loss of life and limb. These parameters can be used as a basis for sorting and assigning retrofit/repair/rehabilitation priorities. The choice of sorting strategy can be left to the value-system that is adopted by the owning agency and/or underwriting authority.

References

- Basöz, N. and Kiremidjian, A.S., (1998), *Evaluation of Bridge Damage Data from the Loma Prieta and Northridge, CA Earthquakes*, Technical Report MCEER-98-0004, Multidisciplinary Center for Earthquake Engineering Research, Buffalo, New York.
- Basöz, N. and Mander, J.B., (1999), *Enhancement of the Highway Transportation Lifeline Module in HAZUS*, Final Pre-Publication Draft (#7) prepared for the National Institute of Building Sciences, March 31, 1999.
- Dutta, A., (1999), *On Energy-Based Seismic Analysis and Design of Highway Bridges*, Ph.D. Dissertation, Science and Engineering Library, University at Buffalo, State University of New York, Buffalo, New York.
- Dutta, A. and Mander, J.B., (1998), "Seismic Fragility Analysis of Highway Bridges," *INCEDE-MCEER Center-to-Center Workshop on Earthquake Engineering Frontiers in Transportation Systems*, Tokyo, Japan, June.
- HAZUS, (1997), *Earthquake Loss Estimation Methodology*, Technical Manual, National Institute of Building Sciences for the Federal Emergency Management Agency.
- Pekcan, G., (1998), *Design of Seismic Energy Dissipation Systems for Concrete and Steel Structures*, Ph.D. Dissertation, University at Buffalo, State University of New York, Buffalo, New York.
- Werner, S.D., Taylor, C.E., Moore, J.E., Jr., Mander, J.B., Jernigan, J.B. and Hwang, H.M., (1998), "New Developments in Seismic Risk Analysis Highway Systems," *30th UJNR Panel Meeting on Wind and Seismic Effects*, Gaithersburg, Maryland.
- Werner, S.D., Taylor, C.E., Moore, J.E. and Walton, J.S., (1999), *Seismic Retrofitting Manuals for Highway Systems, Volume I, Seismic Risk Analysis of Highway Systems*, and *Technical Report for Volume I*, Multidisciplinary Center for Earthquake Engineering Research, Buffalo, New York.

Changes in the New AASHTO Guide Specifications for Seismic Isolation Design

by Michael C. Constantinou,
University at Buffalo, State University of New York

Research Objectives

Two projects at the University at Buffalo under sponsorship of MCEER concentrated, respectively, on establishing new values of response modification factors for substructures of seismically isolated bridges, and on the study of the longevity and reliability of seismic isolation hardware. The latter culminated in the development of the concept of system property modification factors. This concept and the new values of response modification factors have been implemented in the new *AASHTO Guide Specifications for Seismic Isolation Design*.

In 1993, a project began at the University at Buffalo under the title “Longevity and Reliability of Sliding Seismic Isolation Systems” with the support of MCEER. The objectives of the project were then defined as the collection of laboratory and field data on the behavior of sliding bearings and the qualitative prediction of the long-term frictional properties of these bearings. In 1995, the author of this paper became involved in the development of the new *AASHTO Guide Specifications for Seismic Isolation Design* as a member of a task group of the T-3 Seismic Design Technical Committee of the AASHTO Bridge Committee. Specific challenges for the T-3 task group were the proposal of new response modification factors for bridge substructures and the justification thereof, and the development of a rational procedure for determining bounding values of isolator properties for analysis and design.

Based on the needs of the T-3 task group, the objectives of the research project were modified to include the development of a procedure for establishing bounding values of isolator properties. Moreover, a new project began in 1996 at the University at Buffalo with the support of MCEER to develop appropriate response modification factors for the substructures of seismically isolated bridges. These efforts culminated in the establishment of the concept of System Property Modification Factors, the development of revised values for response modification factors, and the inclusion of both in the new *AASHTO Guide Specifications*, which were published in 1999 (American Association of Highway and Transportation Officials, 1999).

Sponsors

MCEER Highway Project
MCEER/NSF

Collaborative Partners

AASHTO T-3 Task Group

James E. Roberts, Chairman,
California Department of
Transportation

Roberto Lacalle and
Li-Hong Sheng, Working
Chairman/Co-chair,
California Department of
Transportation

Ralph E. Anderson, Illinois
Department of Transporta-
tion

Paul Bradford, R.J. Watson,
Inc.

Michael C. Constantinou,
University at Buffalo, State
University of New York

Hamid Ghasemi, Federal
Highway Administration

James M. Kelly and **Ian
Aiken**, University of
California, Berkeley

Myint M. Lwin, Washington
Department of Transporta-
tion

Ronald L. Mayes, Dynamic
Isolation Systems

John F. Stanton, University
of Washington

Victor A. Zayas, Earthquake
Protection Systems

Related Highway Project Tasks

- *Development of Earthquake Protective Systems for Bridge Retrofit: Stability of Elastomeric Bearings, I.G. Buckle, University of Auckland, Energy Dissipation Systems, M. Shinozuka, University of Southern California, Comparative Assessment, M. Feng, University of California, Irvine*
- *Evaluation of Mechanical Property Changes for HDNR Bearings Over Time, J. Kelly, University of California, Berkeley*
- *Field Testing of a Seismically Isolated Bridge, S. Chen and J. Mander, University at Buffalo, and B. Douglas, University of Nevada-Reno*

Changes in the New AASHTO Guide Specifications for Seismic Isolation Design

The new specifications were developed by the T-3 task group during the period of 1995 to 1997 by considering the then current state-of-practice and the results of completed and ongoing research efforts. A number of changes in the new specifications over the predecessor specifications of 1991 are significant, either because they drastically change the analysis and design procedures or because they impose constraints that limit the application of some isolation systems.

Some of the changes are:

- The methods of analysis have been modified to include the effect of the flexibility of the substructure. The substructure increases the flexibility of the structural system and results in a damping ratio that is less than that of the isolation system (provided that there is no inelastic action in the substructure). The result is a net increase in the displacement of the structural system, which usually is related
- The requirements for sufficient lateral restoring force have been changed so that the use of isolation systems with very low restoring force is disallowed in order to prevent the accumulation of large permanent displacements and to reduce the sensitivity of the displacement response to the details of the seismic input. Experimental results from another NCEER-funded project (Tsopelas and Constantinou, 1994) was the impetus for the implementation of this change.
- The response modification factors (R-factors) for the substructure of isolated bridges has been reduced so that, effectively, the substructure remains elastic. The T-3 task group endorsed a proposal by the author and reduced the R-factor on the basis of a small number of analytical results and engineering judgement. Research conducted in the meantime established the

to an increase in the isolation system displacement. These phenomena have been convincingly demonstrated in NCEER-funded research (Constantinou et al., 1993, Tsopelas et al., 1994).

Results of this research have been included in the *AASHTO Guide Specifications for Seismic Isolation Design*, published in 1999, where they represent the two major changes over the predecessor 1991 Specifications. The concept of system property modification factors is considered an innovation in the design of seismically isolated bridges and has been proposed for inclusion in the *Structural Engineers Association of California Blue Book* and the *NEHRP Recommended Provisions*, which apply for buildings. It is expected that this design concept will be both mandated and regularly used in the design of seismically isolated building and bridge structures.

necessity for lower R-factors on the basis of a comprehensive analysis, and verified the appropriateness of the selected values (Constantinou and Quarshie, 1998).

- A procedure for determining bounding values of the isolator properties for analysis and design has been included. This procedure is based on the determination of system property modification factors, or λ -factors, which account for the effects of aging, environment, contamination, history of loading and other conditions on the mechanical properties of isolators. The concept represents a drastic departure from previous practice and it is a bold procedure for considering the long-term behavior of the isolators rather than just their short-term performance in the laboratory. The concept, together with an extensive collection of data to support it, has been the result of a long-term MCEER-funded project (Constantinou et al., 1999).

Response Modification Factor

Response modification factors (R-factors) are used to calculate the design forces in the substructures of bridges from the elastic force demand. That is, the demand is calculated on the assumption of elastic substructure behavior and subsequently the design forces are established by dividing the elastic force demand by the R-factor.

The R-factor consists of two components. That is,

$$R = R_{\mu} \cdot R_o \quad (1)$$

where R_{μ} is the ductility-based portion and R_o is the overstrength factor. The ductility-based portion is the result of inelastic action in the system. The overstrength factor is the result of reserve strength that exists between the design force and the actual yield strength. Single column substructures of bridges have no overstrength (that is, $R_o = 1.0$), whereas multiple column bent substructures have overstrength which typically is assumed to correspond to $R_o = 1.67$.

The ductility-based portion of the R-factor has been presumed to be related to the ability of the substructure to undergo inelastic action. Accordingly, the original 1991 *AASHTO Guide Specifications for Seismic Isolation Design* specified R-factors that were identical to those specified for the substructures of conventional, non-isolated bridges. The assumption was thus made that the inelastic demand in the substructures of seismically isolated and non-isolated bridges would be the same if the two were designed for the same R-factor.

This presumption was incorrect. The demand in the substructure of seismically isolated bridges is strongly dependent on the relation between the strength of the isolation system and the strength of the substructure. It is apparent that the strength of the substructure should be higher than that of the isolation system, or otherwise the isolation system becomes totally ineffective. This principle has been convincingly demonstrated in a series of simple examples by Constantinou and Quarshie (1998), who also performed a systematic study for establishing appropriate values for the R-factor.

Results of Analysis on R-factors for Seismically Isolated Bridges

Figure 1 shows a simple deck-isolation system-substructure model used in the study of Constantinou and Quarshie (1998). A variety of behaviors for the isolation system and substructure are shown in Figure 1, and a range of parameters were considered in the dynamic analysis of this system. Analysis was performed as follows:

- For a particular combination of parameters characterizing the system, analysis was performed assuming elastic substructure behavior and utilizing the simplified analysis procedures of AASHTO.
- The strength of the substructure was then established as the calculated elastic force demand divided by the R-factor. The latter is now just the ductility-based portion since the system lacks redundancy.
- The system was then analyzed and its nonlinear response history was calculated for 20 earthquake motions which were appropriately scaled to represent the applicable response spectrum.
- The analysis results were used to calculate, among other quantities, the average displacement ductility ratio in the substructure which provided the most useful information in establishing appropriate values of the R-factor.

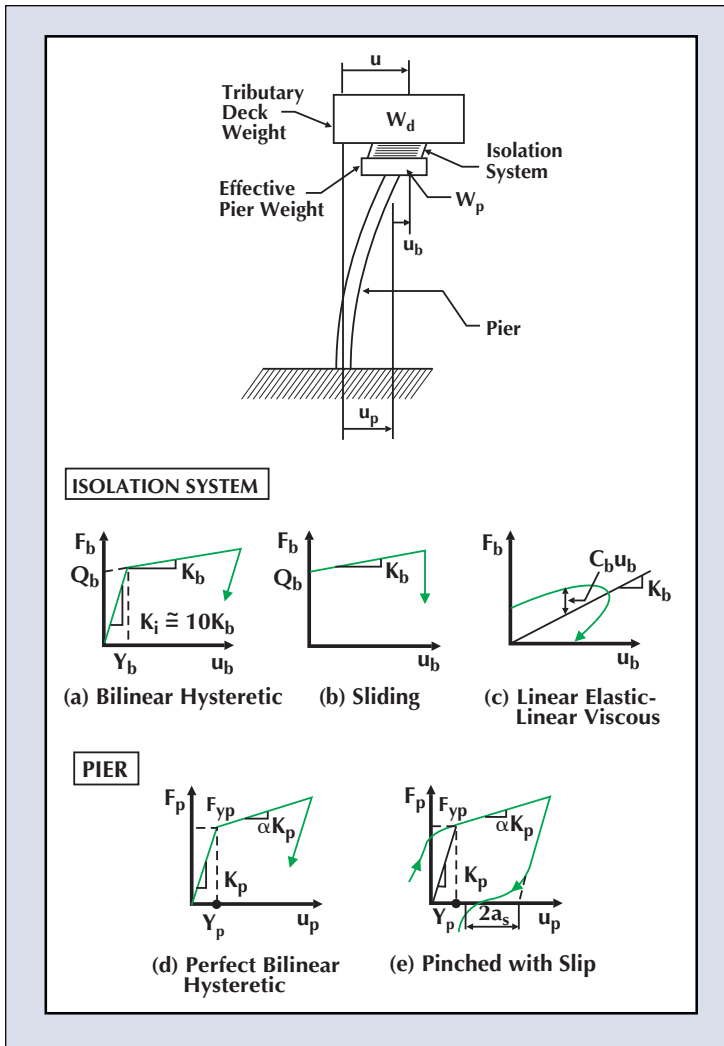

■ Figure 1. Analyzed System and Illustration of Utilized Force-Displacement Relations for Isolation System and Pier

■ **Table 1. Average Substructure Displacement Ductility Ratio of Isolated Bridges**

System	$R_{\mu}=1.0$	$R_{\mu}=1.5$
Bilinear Hysteretic Pier, A = 0.4, Soil Type II, Bilinear Hysteretic Isolation System $\delta = 0.06$	1.2-1.8	2.4-4.7
Bilinear Hysteretic Pier, A = 0.4, Soil Type II, Bilinear Hysteretic Isolation System $\delta = 0.10$	1.3-2.1	2.8-6.5
Bilinear Hysteretic Pier, A = 0.4, Soil Type II, Linear Elastic/Viscous Isolation System $\xi = 0.2$	1.4-1.6	3.0-4.0
Bilinear Hysteretic Pier, A = 0.4, Soil Type II, Linear Elastic/Viscous Isolation System $\xi = 0.3$	1.4-1.5	3.0-4.2
Bilinear Hysteretic Pier, A = 0.4, Soil Type III, Bilinear Hysteretic Isolation System $\delta = 0.06$	0.9-1.4	2.2-4.3
Bilinear Hysteretic Pier, A = 0.4, Soil Type III, Bilinear Hysteretic Isolation System $\delta = 0.10$	0.9-1.5	1.9-4.9
Bilinear Hysteretic Pier, A = 0.4, Soil Type III, Linear Elastic/Viscous Isolation System $\xi = 0.2$	0.9-1.6	1.7-3.9
Bilinear Hysteretic Pier, A = 0.4, Soil Type III, Linear Elastic/Viscous Isolation System $\xi = 0.3$	0.9-1.3	2.2-4.0
Pinched Hysteretic Pier, A = 0.4, Soil Type II, Bilinear Hysteretic Isolation System $\delta = 0.06$	1.5-2.1	2.8-5.4
Pinched Hysteretic Pier, A = 0.4, Soil Type II, Bilinear Hysteretic Isolation System $\delta = 0.10$	1.5-2.4	3.1-6.7

■ **Table 2. Average Substructure Displacement Ductility Ratio of Non-Isolated Bridges**

System	$R_{\mu}=1.0$	$R_{\mu}=2.0$	$R_{\mu}=3.0$
Bilinear Hysteretic Pier A = 0.4, Soil Type II	0.9	1.9	3.5
Bilinear Hysteretic Pier A = 0.4, Soil Type III*	1.4	3.1	5.2
Pinched Hysteretic Pier A = 0.4, Soil Type II	0.9	2.9	4.6

* **Conservative values**

“It is expected that the system property modification factors concept will be both mandated and regularly used in the design of seismically isolated building and bridge structures.”

On the basis of such comparisons, and additional results on the sensitivity of the substructure inelastic response of isolated bridges, it was concluded that the ductility-based portion of the substructures of isolated bridges should be less than or equal to 1.5. Moreover, analyses of the overstrength in isolated bridges have shown that, in general, the overstrength is slightly higher than in non-isolated bridges. Finally, values of the R-factor for isolated bridges have been established and are presented in Table 3. Nearly identical values (1.5 instead of 1.67) have been included in the new *AASHTO Guide Specifications for Seismic Isolation Design*.

System Property Modification Factors

The properties of seismic isolation bearings vary due to the effects of wear, aging, temperature, history of loading, and so on. The exact state of the bearings at the time of seismic excitation cannot be known. However, it is possible to establish maximum and minimum probable values of important properties (i.e., characteristic strength and post-yielding stiffness) within the lifetime of the structure. The analysis can then be conducted twice using the bounding values of properties. In general, the maximum force and displacement responses will be obtained in these analyses.

In principle, the probable maximum and minimum property values

■ Table 3. Proposed Values of R-factor for Substructures of Isolated Bridges

Substructure	R_{μ}	R_o	R
Wall-Type Pier (Strong Direction)	1.0	1.67	1.67
Wall-Type Pier (Weak Direction, Designed as a Column)	1.5	1.0	1.5
Single Columns	1.5	1.0	1.5
Multiple Column Bent	1.5	1.67	2.5

could be established on the basis of statistical analysis of the variability of the properties and the likelihood of occurrence of relevant events, including that of the considered seismic excitation. This is an admittedly very difficult problem. However, it is relatively easier to assess the effect of a particular phenomenon on the properties of a selected type of bearing, either by testing (e.g., effect of temperature on friction coefficient in sliding bearings) or by a combination of testing, rational analysis and engineering judgement (e.g., effect of aging). This leads to the establishment of system property modification factors, that is, factors which quantify the effect of a particular phenomenon on the nominal properties of an isolation bearing, or system in general.

Consider that a nominal value of a property of an isolation system is known. It could be that this value is assumed (on the basis of experience from previous testing) during the analysis and design phase of the project or it is determined in the prototype bearing testing. Typically, this nominal value applies for specific conditions, such as fresh bearing conditions, temperature of 20°C and the relevant conditions of vertical load, frequency or velocity and strain or displacement. Let this value be P_n .

The minimum and maximum values of this property, P_{max} and P_{min} respectively, are defined as the product of the nominal value and a series of System Property Modification Factors, or λ -factors as follows:

$$P_{max} = \lambda_{max} \cdot P_n \quad (2)$$

$$P_{min} = \lambda_{min} \cdot P_n \quad (3)$$

where

$$\lambda_{max} = \lambda_{max,1} \cdot \lambda_{max,2} \cdot \lambda_{max,3} \cdots \quad (4)$$

$$\lambda_{min} = \lambda_{min,1} \cdot \lambda_{min,2} \cdot \lambda_{min,3} \cdots \quad (5)$$

Each of the $\lambda_{max,i}$, $i = 1, 2 \cdots$ factors is larger than or equal to unity, whereas each of the $\lambda_{min,i}$, $i = 1, 2 \cdots$ is less or equal to unity. Moreover, each of the λ -factors is associated with a different aspect of the isolation system, such as wear, contamination, aging, history of loading, temperature, and so on.

As an example, consider the effect of temperature on the friction coefficient of a sliding bearing. The range of temperature over the lifetime of the structure is first established for the particular site or general geographic area of the project. This range need not be one of the extreme (lowest and highest) temperatures. Rather, it could be a representative range determined by the responsible professional (more appropriately, this range could be included in the applicable specifications). Say this range of temperature is -10°C to 50°C . Testing is then performed at the two temperatures and the λ -factors are established as the ratio of the coefficient of friction at

the tested temperature to the coefficient of friction at the reference temperature (say 20°C). Factor $\lambda_{min,t}$ will be based on the data for the highest temperature (50°C), whereas $\lambda_{max,t}$ will be based on the data for the lowest temperature (-10°C).

As another example, consider the effect of wear on the friction coefficient. On the basis of the geometric characteristics of the bridge (span, girder depth, etc.), average vehicle crossing rate and lifetime of the structure, the cumulative travel is determined. Test data are then utilized to establish the λ -factors for wear (or travel). Typically, $\lambda_{max,tr}$ is the ratio of the coefficients of friction determined in high velocity testing following to and prior to a sustained test at the appropriate velocity ($\sim 1\text{mm/s}$) for a total movement equal to the calculated cumulative travel. The $\lambda_{min,tr}$ is determined in a similar manner but for a total movement less than the calculated cumulative travel for which the coefficient of friction attains its least value.

The system property modification factors are associated with different aspects of the isolation system and combined on the basis of (4) and (5). While each one of these factors describes the range of effect of a particular aspect, their multiplication results in a combined factor of which the value may be very conservative. That is, the probability that several events (such as lowest temperature, maximum travel, maximum corrosion, etc.) occur simultaneously with the design-basis earthquake is very small.

It is necessary that some adjustment of the system property modification factors is applied to reflect the de-sired degree of conservatism. This adjustment should be based on a statistical analysis of the property variations with time, the probability of occurrence of joint events and the significance of the structure. It is also desirable to apply this adjustment with the simplest possible procedure.

Such a procedure is based on system property adjustment factors, a , such that the adjusted value of the λ -factor is given by

$$\lambda_{max}^{adjusted} = 1 + (\lambda_{max} - 1) \cdot a \quad (6)$$

$$\lambda_{min}^{adjusted} = 1 + (1 - \lambda_{min}) \cdot a \quad (7)$$

That is, the property adjustment factor is multiplied by the amount by which the λ -factor differs from unity and the result is added to unity to yield the adjusted λ -factor. It is evident that the adjustment factor can take values in the range of 0 to 1. The value $a = 0$ results in an adjusted λ -factor of unity (that is, variations in properties are disregarded - least conservative approach). The value $a = 1$ results in no adjustment (that is, the maximum variations are considered to occur simultaneously - most conservative approach).

The following system property adjust-

ment factors have been proposed by the author and included in the new *AASHTO Guide Specifications*:

- 1 for critical bridges
- 0.75 for essential bridges
- 0.66 for all other bridges

These values are based on engineering judgement and a desire to employ the most conservative design approach for critical bridges. It is expected that as experience develops over the years of observation of the performance of seismically isolated bridges and other structures, and more data are collected on the variations of properties, more refined values of system property adjustment factors could be established.

Values of λ -factors have been established for sliding and elastomeric isolation systems on the basis of a long-term study which included a comprehensive review and analysis of available data, extensive testing, application of principles of solid mechanics and use of engineering judgement (Constantinou et al., 1999). There are too many

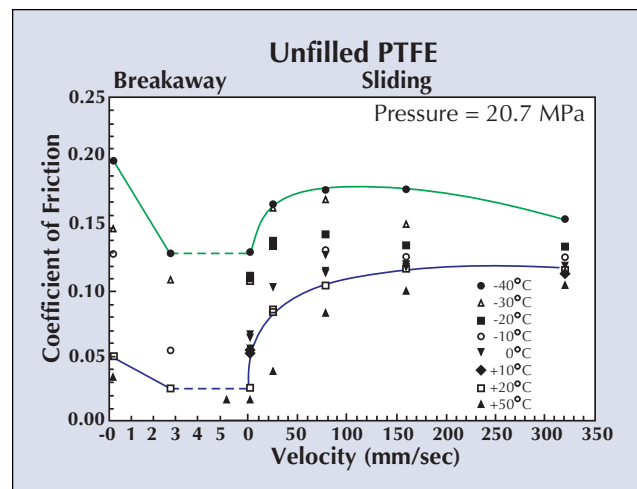

Figure 2. Friction of Unfilled PTFE-Polished Stainless Steel Interfaces at Various Temperatures as Function of Sliding Velocity

■ **Table 4.** System Property Modification Factor for Effects of Temperature ($\lambda_{max,T}$) on the Coefficient of Friction of Sliding Bearings

Temperature (°C)	Unlubricated PTFE	Lubricated PTFE	Bimetallic Interfaces
20	1.0	1.0	N/A
0	1.1	1.3	N/A
-10	1.2	1.5	N/A
-30	1.5	3.0	N/A
-40	1.7	N/A	N/A
-50	2.0	N/A	N/A

factors to describe each one and the physical phenomena responsible for the effects. It is sufficient to present herein some representative results on one of the effects and the related λ -factors.

Low temperature causes an increase in the friction of PTFE-stainless steel interfaces used in sliding bearings and in the stiffness and characteristic strength of elastomeric bearings. The effect in the case of elastomers is time-dependent, that is, the increase in stiffness is greater with increasing time of exposure at a particular low temperature. For sliding interfaces, the effect of low temperature is highly dependent on the speed of sliding motion since frictional heating can cause substantial increases in temperature following very small travel.

While testing of seismic isolation bearings at low temperature is a relatively straight forward exercise (albeit not an easy one), the interpretation of the results and the establishment of λ -factors requires an understanding of the frictional heating problem. Figure 2 presents a sample of experimental results on the frictional properties of unfilled PTFE-highly polished stainless steel interfaces for a range of velocities of sliding, and temperature at the start of the experiment. The substantial effect of frictional heating, as made evident in the figure with

the increased velocity, is apparent. On the basis of these and other results, which were generated in very time-consuming experiments, the λ -factors of Table 4 were developed (Constantinou et

al., 1999) and incorporated in the new *AASHTO Guide Specifications*.

To assess the effect of frictional heating, an analytic solution was derived to predict the temperature rise at the sliding interface and at some depth below. Carefully planned experiments (including the use of extremely fine thermocouple wires) were also conducted to obtain reliable measurements of histories of temperature rise

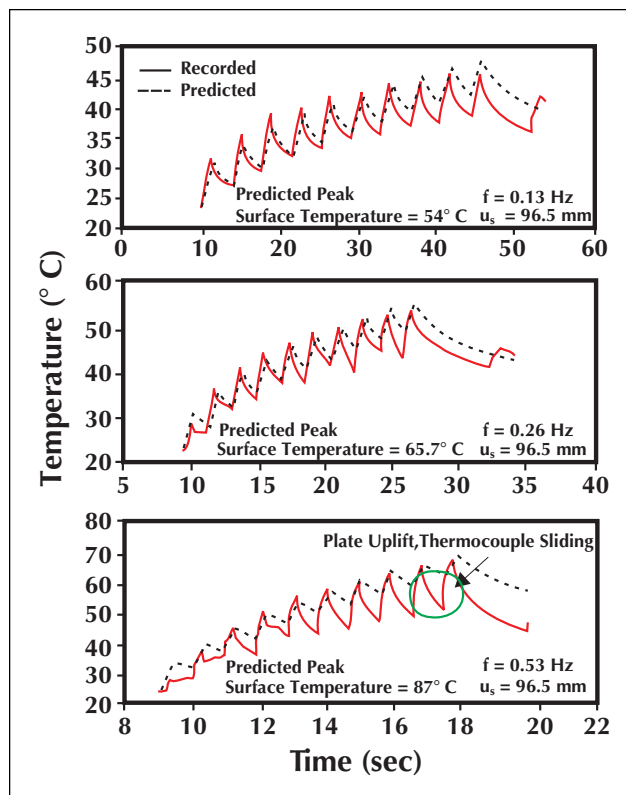

■ **Figure 3.** Recorded and Predicted Histories of Temperature at Depth of 1.5 mm Below the Sliding Interface in Large Amplitude Tests

for verification of the theory. Figure 3 presents a comparison of measured and predicted histories of temperature during testing of a sliding bearing.

Conclusions

Research supported by MCEER resulted in the establishment of new response modification factors for the substructures of seismically isolated bridges and in the development of a new concept in the analysis seismically isolated structures.

Both developments have been incorporated in the new *AASHTO Guide Specifications for Seismic*

Isolation Design, which were published in 1999.

Of particular interest in this work is the development of the concept of system property modification factors and the substantial multi-year effort to establish values for these factors on the basis of testing, rational analysis and engineering judgement. Despite this effort, there are a significant number of problems that could not be adequately addressed in this research. Most important of these problems is that of the prediction of the aging characteristics of seismic isolation hardware, which requires a substantial, multidisciplinary basic research effort to adequately address.

References

- American Association of State Highway and Transportation Officials (AASHTO), (1999), *Guide Specifications for Seismic Isolation Design*, Washington, D.C.
- Constantinou, M.C., Tsopelas, P., Kim, Y.S. and Okamoto, S., (1993), *NCEER-Taisei Corporation Research Program on Sliding Seismic Isolation Systems for Bridges: Experimental and Analytical Study of a Friction Pendulum System (FPS)*, Technical Report NCEER-93-0020, Multidisciplinary Center for Earthquake Engineering Research, Buffalo, New York.
- Constantinou, M.C. and Quarshie, J.K., (1998), *Response Modification Factors for Seismically Isolated Bridges*, Technical Report MCEER-98-0014, Multidisciplinary Center for Earthquake Engineering Research, Buffalo, New York.
- Constantinou, M.C., Tsopelas, P., Kasalanati, A. and Wolff, E., (1999), *Property Modification Factors for Seismic Isolation Bearings*, Technical Report MCEER-99-0012, Multidisciplinary Center for Earthquake Engineering Research, Buffalo, New York.
- Tsopelas, P. and Constantinou, M.C., (1994), *NCEER-Taisei Corporation Research Program on Sliding Seismic Isolation Systems for Bridges: Experimental and Analytical Study of a System Consisting of Lubricated PTFE Sliding Bearings and Mild Steel Dampers*, Technical Report NCEER-94-0022, Multidisciplinary Center for Earthquake Engineering Research, Buffalo, New York.
- Tsopelas, P., Okamoto, S., Constantinou, M.C., Ozaki, D. and Fujii, S., (1994), *NCEER-Taisei Corporation Research Program on Sliding Seismic Isolation Systems for Bridges: Experimental and Analytical Study of Systems Consisting of Sliding Bearings, Rubber Restoring Force Devices and Fluid Dampers*, Technical Report NCEER-94-0002, Multidisciplinary Center for Earthquake Engineering Research, Buffalo, New York.

Seismic Retrofitting Manuals for Highway Systems

by *Ian M. Friedland, Multidisciplinary Center for Earthquake Engineering Research and
Ian G. Buckle, University of Auckland*

Research Objectives

The MCEER Highway Project is developing a set of guidelines for conducting seismic hazard evaluations and retrofitting of highway systems and system components. These guidelines will provide assistance in performing seismic vulnerability screening, evaluation and retrofitting of highway system components including bridges, retaining structures, slopes, tunnels, culverts, and pavements, and in determining the impacts of scenario earthquakes on highway system performance, including traffic flows, economic consequences and other factors. The guidelines will be contained in the three-volume *Seismic Retrofitting Manuals for Highway Systems*. Volume I will contain procedures for conducting a seismic risk assessment of highway systems and regional networks, Volume II will contain procedures for seismic screening, evaluation and retrofitting of highway bridges, and Volume III will contain similar procedures for retaining structures, slopes, tunnels, culverts and pavements.

In the fall of 1992, MCEER initiated work on a comprehensive research program, sponsored by the Federal Highway Administration, to develop and improve tools to evaluate the seismic vulnerability of the national highway system in the United States. The research program includes a series of tasks intended to improve understanding of the seismic hazard in the eastern and central U.S.; the behavior and response of soils, foundations and highway structures during earthquakes; and the overall impacts on highway systems resulting from earthquake damage. In addition, the program is developing and improving appropriate retrofit technologies for those highway system components deemed vulnerable to earthquake damage.

An important end-product of this program is the development of seismic evaluation and retrofitting guidelines for existing highway systems which will have *national applicability*. These guidelines are being prepared in three volumes, where:

- Volume I contains the methodologies, procedures, and examples for conducting a seismic risk assessment of highway networks and systems;

Sponsors

MCEER Highway Project

Volume Coordinators

*Ian G. Buckle, University of
Auckland*

*Ian M. Friedland, MCEER
Maurice S. Power,
Geomatrix Consultants,
Inc.*

*Stuart D. Werner, Seismic
Systems and Engineering
Consultants*

Volume 1 Contributors

Stuart D. Werner, *Coordinator, Seismic Systems and Engineering Consultants*

Craig E. Taylor, *Natural Hazards Management, Inc.*

James E. Moore II, *University of Southern California*

Masanobu Shinozuka, *University of Southern California*

Jon Walton, *City of San Jose*

Volume II Contributors

Ian G. Buckle, *Coordinator, University of Auckland*

Ian M. Friedland, *MCEER*

John B. Mander, *University at Buffalo*

Geoffrey R. Martin, *University of Southern California*

Richard V. Nutt, *Consultant*

Maurice S. Power, *Geomatrix Consultants, Inc.*

Volume III Contributors

Maurice S. Power, *Coordinator, Geomatrix Consultants, Inc.*

Geoffrey R. Martin, *Co-coordinator, University of Southern California*

Rowland Richards, *University at Buffalo*

Kenneth Fishman, *University at Buffalo*

Faiz Makdisi, *Geomatrix Consultants, Inc.*

Dario Rosidi, *Geomatrix Consultants, Inc.*

Jon Kaneshiro, *Parsons Engineering Science, Inc.*

Samuel C. Musser, *Utah Department of Transportation*

T. Leslie Youd, *Brigham Young University*

- Volume II contains guidance on seismic vulnerability screening, analysis, and retrofitting of highway bridges; and
- Volume III contains guidance on screening, analysis, and retrofitting of other major highway system components, including retaining structures, slopes, tunnels, culverts, and pavements.

As a first step towards the completion of each of these volumes, a “strawman” was prepared in late 1996 for Volumes I (system risk assessment) and III (evaluation and retrofitting of components other than bridges). Each strawman:

1. Summarized the current state-of-practice in highway system assessment, component evaluation, and retrofitting.
2. Incorporated current research results.
3. Identified important gaps in knowledge which required resolution prior to completion of each volume.

The 1995 FHWA *Seismic Retrofitting Manual for Highway Bridges* (FHWA, 1995), which was

also prepared by MCEER, served as the “strawman” for Volume II. Work on the final versions of each volume commenced in late 1997; drafts of each have been completed and distributed to a select group of researchers and practitioners for detailed technical reviews. Following final revisions and edits, it is anticipated that each of these three volumes will be published and available for distribution by the FHWA in the year 2000.

This paper provides an overview on the intent and coverage of each volume of these retrofitting guidelines.

Seismic Risk Assessment of Highway Systems

Past experience has shown that the direct impacts of earthquake damage to highway structures (e.g., bridges, retaining structures, and tunnels) is both a life-safety issue and a repair and replacement cost issue. Furthermore, indirect impacts from closed or restricted

The *Seismic Retrofitting Manuals for Highway Systems* will provide engineers with necessary knowledge concerning current state of the art regarding the performance of bridge and other highway structures during earthquakes, methods to strengthen them, and tools to determine how and when to retrofit. These manuals are intended to be used with the seismic design requirements for new highway bridges contained in the American Association of State Highway and Transportation Officials (AASHTO) Specifications. Private, local, state and federal bridge and highway engineers throughout the country will find these manuals useful in developing retrofit strategies. Emergency managers and planning professionals can use these manuals to determine appropriate levels of lifeline route planning and redundancy.

routes, disrupted access and delayed post-earthquake emergency response, repair, and reconstruction operations can be as costly or greater than the actual direct structural damage and repair costs.

The extent of these impacts depends not only on the seismic performance characteristics of the individual components, but also on the characteristics of the highway system that contains these components. For example, studies of highway systems in the San Francisco Bay area after the 1989 Loma Prieta earthquake have shown that post-earthquake traffic flows strongly depended on the following factors (Hobeika et al., 1991; Wakabayashi and Kameda, 1992):

- the configuration of the highway system;
- the locations of the individual components within the overall system and within specific links and subsystems; and
- the locations, redundancy, and traffic capacities and volumes of the links between key origins and destinations within the system.

When one considers these system characteristics, it is evident that earthquake damage to certain components (e.g., those along important and nonredundant links within the system) will have a greater impact on overall system performance than will other components. Currently, such system issues are not considered when specifying seismic performance requirements and design or retrofitting criteria for new or existing components, due primarily to the lack of adequate systems-based evaluation tools.

Instead, each component type is usually evaluated individually, with

screening and ranking criteria applied specifically to the inventory of structures of the same type. For example, formal screening and ranking guidelines for highway bridges have existed since the early 1980s (FHWA, 1983). However, such procedures treat each individual component independently, without regard to how the extent of its damage may affect overall highway performance.

Consideration of each component's importance to system performance can provide a much more rational basis for:

- establishing seismic strengthening priorities;
- defining seismic design and strengthening criteria;
- effecting emergency lifeline route planning; and
- estimating economic impacts due to component damage.

It is important to recognize that system performance issues are important to all regions that are at risk due to earthquakes. As a result, system issues are now being incorporated into newly developed methods for prioritizing bridges for seismic retrofit (Basöz and Kiremidjian, 1995; Moore et al., 1995).

Volume I of the MCEER Highway Project's *Seismic Retrofitting Manuals for Highway Systems* contains procedures for conducting a seismic risk assessment (SRA) of highway networks and systems (Werner et al., 1999). The procedures contained in this volume provide a basis for addressing these seismic performance issues and incorporate data and methodologies pertaining to engineering issues (structural, geotechnical, and transportation), repair and

“This is the first known effort to capture the important aspects of screening, evaluation, and retrofitting of non-bridge highway system structural components and to present results and recommendations in a formal, procedural manner.”

reconstruction, system network and risk analysis, and socioeconomic considerations for impacts from system damage. They also provide a mechanism to estimate system-wide direct losses (i.e., costs for repair of damaged components) and indirect losses due to reduced traffic flows and/or increased travel times (economic impacts).

Specifically, Volume I provides:

- a detailed framework for carrying out deterministic and probabilistic evaluations of seismic risks to highway systems;
- a discussion on the types of data needed to characterize the system, hazards, and components, together with the form of structural, geotechnical, and transportation engineering analysis results needed for these characterizations;
- a procedure for rapid analysis of

post-earthquake traffic flows based on artificial intelligence concepts and the current state of knowledge for traffic flow modeling; and

- a socioeconomic module for characterizing economic, emergency response, and societal impacts of earthquake damage to highway systems

Key to the SRA procedures are four GIS-based modules that act as pre-processors to the procedure in order to model the system, hazards, components, and socioeconomics for the system. This modeling comprises the bulk of the effort in the application of the risk analysis procedure.

The volume provides the background and an overview of the methodology and procedures, and details the four principal modules comprising the SRA:

- the *system module*, which contains system and inventory data, traffic management measures, and system analysis procedures;
- the *hazards module*, which contains the earthquake ground motions, geologic hazard evaluation, liquefaction, landslides, and surface fault rupture information;
- the *component module*, which contains the overall model development including loss and functionality models, seismic response evaluation, and repair and reconstruction procedures; and
- the *socioeconomic module*,

which contains the models and local or regional demographic and economic data needed to estimate the socioeconomic impacts due to reductions in traffic flows

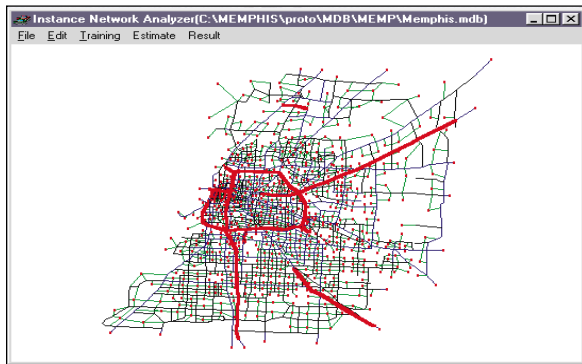

■ Figure 1. Procedures for conducting a Seismic Risk Assessment (SRA) of highway networks and systems is the focus of Volume I. The SRA provides a detailed framework for modeling the system, hazards, components and socioeconomic factors for a given region. Shown above are the Memphis/Shelby County highway system and the entire transportation system for a given post-earthquake state.

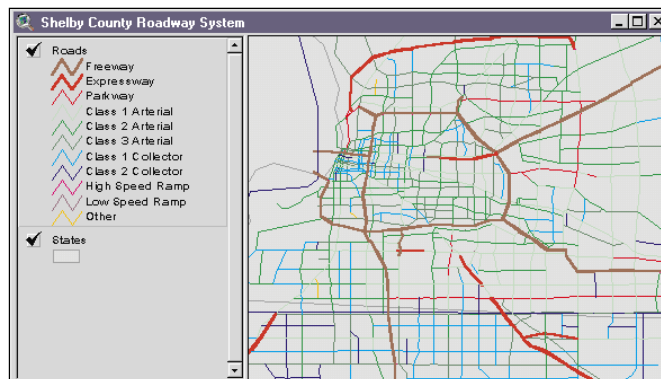

resulting from earthquake damage.

In addition, the volume contains an example application based on the highway system in and around Memphis, Tennessee which demonstrates the application and interpretation of the results of the SRA procedure.

Screening, Evaluation and Retrofitting of Highway Bridges

In the late 1970s, the Applied Technology Council developed a set of guidelines for the seismic retrofitting of highway bridges under FHWA sponsorship. These guidelines were published in 1983 by the FHWA as the *Seismic Retrofitting Guidelines for Highway Bridges* (FHWA, 1983). The guidelines represented what was then the state-of-the-art for screening, evaluating, and retrofitting of seismically deficient bridges. At the time the guidelines were issued, experience with highway bridge retrofitting in the U.S. was limited and many of the proposed techniques had not actually been implemented in field applications. In the 15 or so years since, there has been significant progress in understanding the seismic response of bridges and the development of new and improved retrofitting technologies for bridge columns and footings, methods to stabilize soils to prevent liquefaction, and to ensure adequate connectivity between the bridge superstructure and substructure. Many of these advances

in the state-of-the-art and the state-of-practice are the result of an aggressive research program which was started by the California Department of Transportation (Caltrans) following the 1989 Loma Prieta earthquake. Since then, seismic screening, evaluation, and retrofitting procedures for highway bridges have been widely implemented in parts of North America, Asia, and Europe.

In order to capture these advances in seismic retrofitting and to make the current state-of-the-art available to bridge owners and engineers across the U.S., the FHWA initiated a project to update the 1983

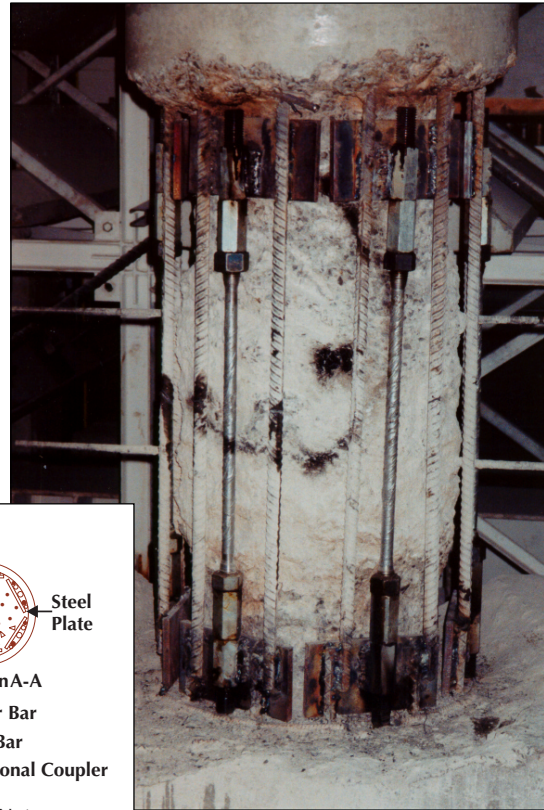
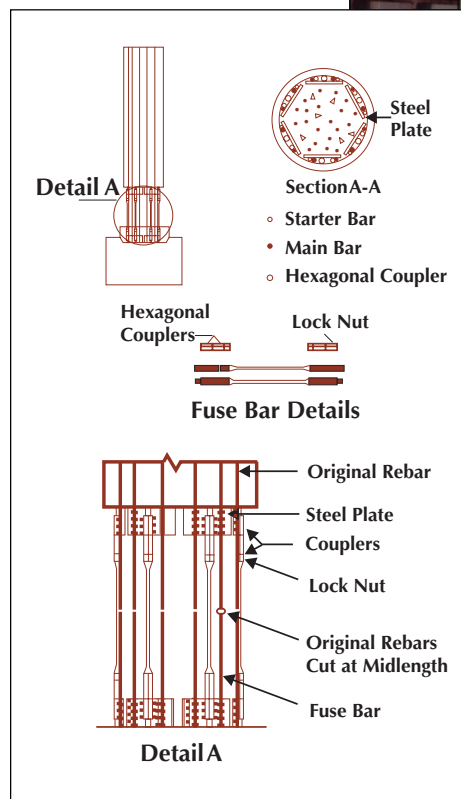

■ Figure 2. Innovative techniques for seismic retrofitting strategies are an integral part of MCEER's highway project research, the results of which are included in Volume II of the retrofit manuals. A Control and Repairability of Damage (CARD) column design philosophy for new structures that uses replaceable fuse bars in the plastic hinge zone is being tested for application in retrofit situations. It is anticipated that this type of retrofit will permit rapid and cost-effective repairs following a damaging earthquake.

Selected Highway Project Tasks

- *Risk Assessment of Highway Systems*, **S. Werner**, *Seismic Systems and Engineering Consultants*
- *State of the Art Review: Foundations and Retaining Structures*, **I.P. Lam**, *Earth Mechanics, Inc.*; *Slopes, Retaining Structures and Pavements*, **G. Santana**, *University of Costa Rica*; *Culverts and Soils and Liquefaction*, **T.L. Youd**, *Brigham Young University*
- *Liquefaction Remediation Techniques for Bridge Foundations*, **G. Martin**, *University of Southern California* and **J. Mitchell**, *Virginia Polytechnic Institute*
- *Improving the Lateral Capacity of Pile Foundations and Pile Foundation Retrofitting Synthesis*, **I.P. Lam**, *Earth Mechanics, Inc.*
- *Pile-to-pile Cap Connections*, **J. Mander**, *University at Buffalo*, **G. Martin** and **Y. Xiao**, *University of Southern California*
- *Seismic Retrofit of Shear Critical Bridge Columns*, **J. Mander**, *University at Buffalo*
- *Evaluation of Seismic Retrofit Methods for Reinforced Concrete Bridge Columns*, **F. Klaiber**, *Iowa State University*
- *Design Procedures for Longitudinal Restraints: Multi-Span Simply Supported Bridges; Multiple-Frame Bridges*, **M. Saiidi**, *University of Nevada-Reno* and **G. Fenves**, *University of California, Berkeley*

guidelines as part of the MCEER Highway Project research program. This effort resulted in the 1995 *Seismic Retrofitting Manual for Highway Bridges*, which was published by the FHWA (FHWA, 1995).

The 1995 FHWA manual offers procedures for evaluating and upgrading the seismic resistance of existing highway bridges. Specifically, it contains:

- a preliminary screening process to identify and prioritize bridges that need to be evaluated for seismic retrofitting;
- alternative methodologies for quantitatively evaluating the seismic capacity of an existing bridge and determining the overall effectiveness of alternative seismic retrofitting measures by either the component-based capacity/demand (C/D) approach or the lateral strength (“push-over”) methodology; and
- suggested retrofit measures and design requirements for increasing the seismic resistance of existing bridges.

The manual does not prescribe requirements dictating when and how bridges are to be retrofitted – the decision to retrofit is left to the engineer and depends on a number of factors. These include, but are not limited to, the availability of funding, and political, social, and other economic considerations. The primary focus of the manual is directed towards providing guidance on the engineering factors for seismic retrofitting.

The 1995 FHWA manual is being updated and significantly expanded, and will be reissued as Volume II of the *Seismic Retrofitting Manuals for Highway Systems* on the basis

of additional research and development conducted under the FHWA-sponsored research program at MCEER, Caltrans, and others. Volume II will be issued in two parts, including:

- the main volume containing the screening, evaluation, and retrofitting procedures for highway bridges, and a series of case-studies demonstrating the application of key parts of various procedures
- a supplementary volume containing engineering drawings and details of typical retrofits, and vendor details and applications of seismic protective systems.

Among the major changes that are included in the new bridge evaluation and retrofitting manual are:

1. significantly expanded coverage of seismic hazards. This includes methods for characterizing the seismic hazard, selecting appropriate return periods and parameters, consideration of local site factors and effects, procedures and rules for constructing elastic spectral demand, guidance on developing time histories, and consideration of vertical ground motions and near-field effects;
2. expanded coverage of potential geotechnical hazards and evaluation of geotechnical components. This includes characterization of geotechnical hazards, identification of liquefaction potential and quantification of liquefaction effects in the free-field, settlement of approach slopes due to ground shaking, and concerns with active faults and fault rupturing underneath the structure. In addition, the new bridge manual

contains guidance on foundation modeling for soil-structure interaction, and stiffness and capacity evaluation of abutments, footings, pile groups, drilled (pier) shafts, and caissons, along with methods to determine liquefaction-based displacement demands;

3. the incorporation of additional methods for bridge system evaluation, including the capacity/demand spectral evaluation (linearized elastic and inelastic R-factor) method, lateral strength (pushover) analysis, and detailed computation methods including nonlinear time history analysis; and
4. expanded coverage of widely employed and new seismic retrofit strategies. Among these are strategies related to strengthening, displacement enhancements, and ground remediation, and a discussion on when the engineer should consider either the full-replacement or “do-nothing” option. The engineering and economic evaluation considerations for selection of appropriate strategies are fully described in the manual.

A large number of new and modified retrofit techniques are described in the manual, including many intended for low-to-moderate seismic zones where cost-effectiveness and simplicity may be as important as moderate increases in seismic performance. Among these new retrofits are hinge shifting and fusible hinge techniques for substandard columns, and methods that provide improved performance for existing steel roller and rocker bearings. In addition, the new volume includes expanded coverage of the use of protective systems as part of the arsenal of potential

retrofit approaches, including the use of energy dissipation systems, seismic isolation, restrainers, and combinations of these technologies.

Recommendations concerning post-earthquake emergency assessment and repair are also being added to the new manual. A new chapter has been added which describes the functions, makeup, and pre-event training and planning for both an emergency damage assessment team and a structural performance investigation team. The emergency damage assessment team is responsible for immediate on-site evaluations of damaged structures to determine if they are capable of safely carrying traffic, while the structural performance investigation team performs on-site evaluations to gather information and data to determine or theorize and document the causes of failure or damage, primary and secondary failure modes and sequences, and the validity of current design practice and codes, relative to observed damage. This chapter also provides guidance in identifying the significance and extent of damage to bridge components commonly put at risk during earthquakes, and in providing suggested temporary shoring and repair strategies.

Screening, Evaluating and Retrofitting of Retaining Structures, Slopes, Tunnels, Culverts and Pavements

Current national highway seismic standards in the U.S. are primarily limited to design and retrofitting provisions for highway bridges.

Selected Highway Project Tasks (cont.)

- *Longitudinal Restrainer Experiments*, **E. Maragakis** and **M. Saiti**, University of Nevada-Reno
- *Development of Earthquake Protective Systems for Bridge Retrofit: Stability of Elastomeric Bearings*, **I.G. Buckle**, University of Auckland; *Energy Dissipation Systems*, **M. Shinozuka**, University of Southern California; *Sliding Isolation Systems*, **M. Constantinou**, University at Buffalo; *Comparative Assessment*, **M. Feng**, University of California, Irvine
- *Evaluation of Mechanical Property Changes for HDNR Bearings Over Time*, **J. Kelly**, University of California, Berkeley
- *R-Factors for Isolated Bridges*, **M. Constantinou**, University at Buffalo
- *Field Testing of a Seismically Isolated Bridge*, **S. Chen** and **J. Mander**, University at Buffalo and **B. Douglas**, University of Nevada-Reno
- *Abutments and Retaining Structures, and Develop Analysis and Design Procedures for Retaining Structures*, **R. Richards** and **K. Fishman**, University at Buffalo

However, a typical highway system is composed of a number of major structural and geotechnical components, which include retaining structures, engineered slopes (cuts and fills), tunnels, culverts, and pavements. In addition, a typical highway system also contains other functional and peripheral elements such as sound walls, sign and light structures (towers and sign bridges), and motorist service facilities. While

these peripheral elements are widespread, the potential impact on traffic flow from their failure during an earthquake is expected to be limited. However, traffic flow impacts from the failure of the other major structural and geotechnical components during an earthquake could be as severe as that historically demonstrated by the failure of highway bridges. This was evident during the 1995

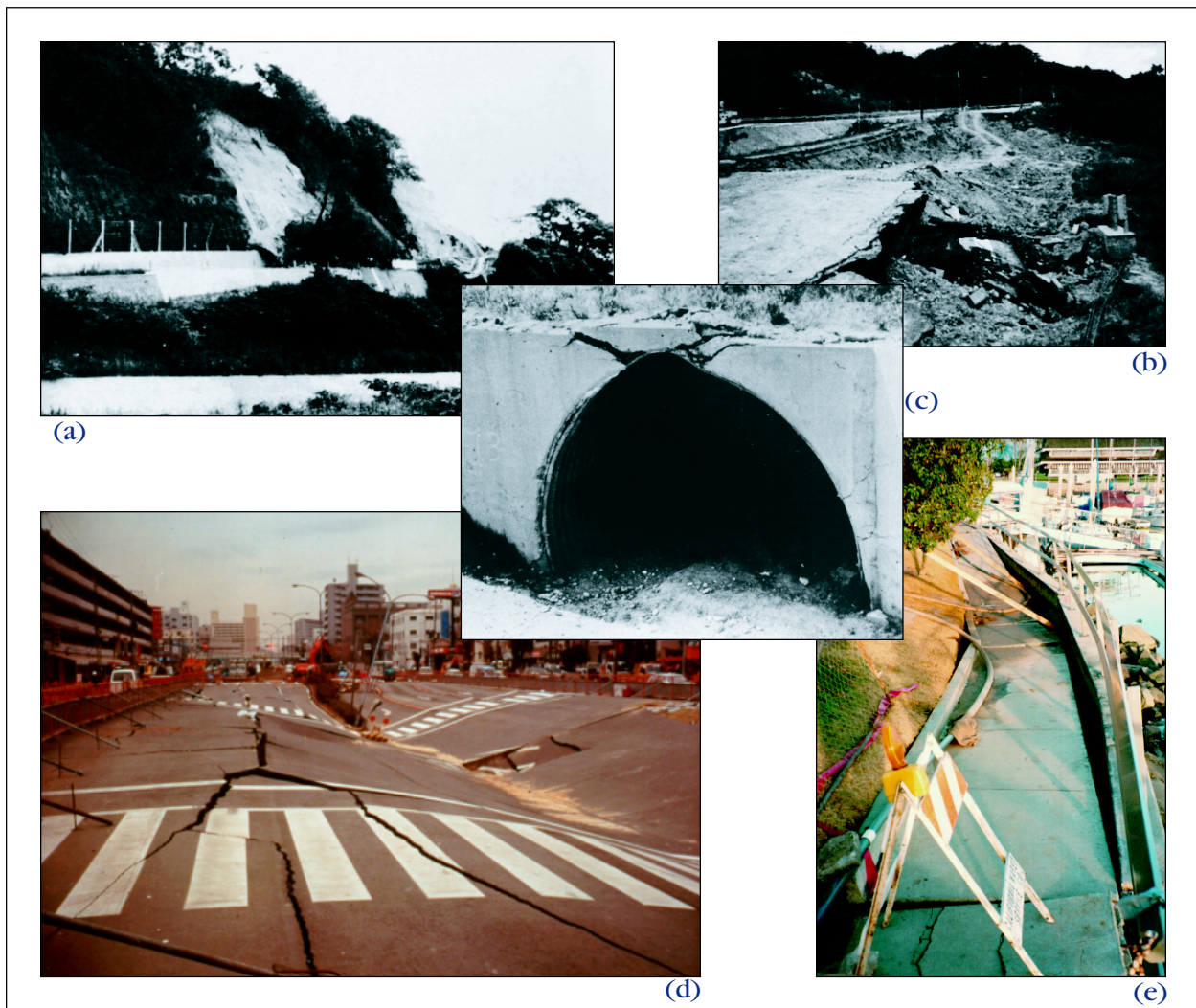

■ Figure 3. Volume III focuses on the development of screening, evaluation and retrofiting of non-bridge components. Experience from past earthquakes has shown that damage to these components can be just as severe and/or destructive as that to the actual bridge structure. Shown above, from left, are: (a) a road severed by a large landslide and (b) pavement damage caused by a failed embankment and flow slide following the Hokkaido Nansei-oki, Japan earthquake; (c) the San Fernando earthquake caused the headwall to fracture and deformed the inlet of this culvert; (d) cracks at the street surface were caused by earthquake damage to tunnels near the Daikai Station in Kobe; and (e) a retaining wall in Redondo Beach was damaged following the Northridge earthquake.

Hanshin-Awaji earthquake in Japan, which resulted in the failure of numerous retaining structures, rail tunnels, and roadway beds.

As a result, Volume III of the *Seismic Retrofitting Manuals for Highway Systems* focuses on the development of screening, evaluation, and retrofitting methods and technologies for these other major highway system structural components. Over time, individual structures have been evaluated and retrofitted on a case-by-case basis. Much of this experience, however, is fragmented and not well-documented. This volume is the first known effort to capture the important aspects of screening, evaluation, and retrofitting of these non-bridge highway system structural components and to present results and recommendations in a formal, procedural manner.

Unlike highway bridges, there is no precedent for a manual for screening, evaluation, and retrofitting of highway retaining structures, slopes, tunnels, culverts, and pavements. The first step in this development, therefore, was the preparation of the strawman document, which summarized the current state of knowledge and practice for these highway system components, incorporated current research results, and identified important gaps in knowledge where additional research was necessary to complete the volume (NCEER, 1996).

Volume III (MCEER, 1999) is composed of five sections (one for each highway component covered in the document). Topics covered within each section cover:

- classification of the structural component;

- seismic vulnerability screening;
- detailed structural evaluation; and
- recommended retrofitting concepts.

The volume discusses factors related to performance criteria and the expected level of service or acceptable damage for each component, based on the anticipated level of seismic shaking. Due to limited previous work on some of these highway system components, the overall philosophy of this volume is intended to be somewhat conservative and anticipates that additional work may be necessary to fully characterize and understand the behavior of some of these highway system components.

Conclusion

The development of the *Seismic Retrofitting Manuals for Highway Systems* is a major component of the MCEER highway project research program being conducted for the Federal Highway Administration (FHWA) and will significantly impact highway engineering practice in the U.S. following their publication. Drafts of the three volumes have been completed and the final versions are expected to be available from the FHWA in mid-2000 following a detailed period of technical review and revision of each volume draft. These volumes will provide the basis for guidance to agencies embarking on a program to evaluate and reduce the seismic vulnerability of highway systems.

References

- Basöz, N. and Kiremidjian, A., (1995), *Prioritization of Bridges for Seismic Retrofitting*, Technical Report NCEER-95-0007, Multidisciplinary Center for Earthquake Engineering Research, Buffalo, New York.
- Federal Highway Administration (FHWA), (1983), *Seismic Retrofitting Guidelines for Highway Bridges*, Report No. FHWA/RD-83/007, U.S. Department of Transportation, Federal Highway Administration, McLean, Virginia.
- Federal Highway Administration (FHWA), (1995), *Seismic Retrofitting Manual for Highway Bridges*, Publication No. FHWA-RD-94-052, U.S. Department of Transportation, Federal Highway Administration, McLean, Virginia.
- Hobeika, A.G., Manchikalapudi, L.N., and Kim, S., (1991), *Transportation Problems Faced After Big Earthquakes: A Case Study of the Loma Prieta Earthquake*, Center for Transportation Research, Virginia Polytechnic Institute and State University, Blacksburg, Virginia.
- Moore, J.E., Kim, G., Xu, R.X., and Cho, S., (1995), *Evaluating System ATMIS Technologies via Rapid Estimation of Network Flows*, MOU-120 Draft Interim Report, California PATH Program, University of California Research Report Nos.VKC-351 and MC-0042, University of Southern California, Los Angeles, California.
- Multidisciplinary Center for Earthquake Engineering Research (MCEER), (1999), *Seismic Retrofitting Manuals for Highway Systems, Volume III, Screening, Evaluation and Retrofitting of Retaining Structures, Slopes, Tunnels, Culverts, and Pavements*, Sections contributed by M.S. Power, K. Fishman, R. Richards, F. Makdisi, S. Musser and T.L. Youd, MCEER Highway Project Task 106-G-3.2, May 1999 Draft, MCEER, Buffalo, New York.
- National Center for Earthquake Engineering Research (NCEER), (1996), *Seismic Retrofitting Manual for Highway Systems: Volume III Strawman - Screening, Evaluation, and Retrofitting of Retaining Structures, Slopes, Tunnels, Culverts, and Pavements*, sections contributed by R. Richards, K. Fishman, F. Makdisi, M. Power, D. Rosidi, J. Kaneshiro, S. Musser, and T.L. Youd, Multidisciplinary Center for Earthquake Engineering Research, Buffalo, New York.
- Wakabayashi, H. and Kameda, H., (1992), "Network Performance of Highway Systems Under Earthquake Effects: A Case Study of the 1989 Loma Prieta Earthquake," *Proceedings of the U.S.-Japan Workshop on Earthquake Disaster Prevention for Lifeline Systems*, Public Works Research Institute, Tsukuba Science City, Japan.
- Werner, S.D., Taylor, C.E., Moore, J.E. and Walton, J.S., (1999), *Seismic Retrofitting Manuals for Highway Systems, Volume I, Seismic Risk Analysis of Highway Systems, and Technical Report for Volume I*, Multidisciplinary Center for Earthquake Engineering Research, Buffalo, New York.

▲ **Acknowledgements**

This report was prepared by the Multidisciplinary Center for Earthquake Engineering Research through grants from the National Science Foundation, a contract from the Federal Highway Administration and funding from New York State and other sponsors.

The material herein is based upon work supported in whole or in part by the National Science Foundation, Federal Highway Administration, New York State and other sponsors. Opinions, findings, conclusions or recommendations expressed in this publication do not necessarily reflect the views of these sponsors or the Research Foundation of the State University of New York.

▲ **Contributors**

Ian G. Buckle, Professor of Civil Engineering and Vice-Chancellor for Research, University of Auckland, New Zealand

Stephanie E. Chang, Assistant Professor of Geography, University of Washington and Project Engineering Economist, EQE International, Inc.

Tsen-Chung Cheng, Lloyd F. Hunt Professor of Electrical Engineering, University of Southern California
Shyh-Jeng Chiou, Senior Seismologist, Geomatrix Consultants, Inc.

Michael C. Constantinou, Professor and Chair, Department of Civil, Structural and Environmental Engineering, University at Buffalo, State University of New York

Ronald T. Eguchi, Vice President, Center for Advanced Planning and Research, EQE International, Inc.

Maria Q. Feng, Associate Professor of Civil Engineering, University of California, Irvine

Ian M. Friedland, Assistant Director for Transportation Research, Multidisciplinary Center for Earthquake Engineering Research

Bijan Houshmand, MCEER Consultant

Charles K. Huyck, GIS Specialist, EQE International, Inc.

Sang-Soo Jeon, Graduate Research Assistant, Cornell University

Dyah Kusumastuti, Graduate Research Assistant, University at Buffalo, State University of New York

George C. Lee, Samuel P. Capen Professor of Engineering, University at Buffalo, State University of New York and Director, Multidisciplinary Center for Earthquake Engineering Research

Zhong Liang, Research Associate Professor, University at Buffalo, State University of New York

John B. Mander, Associate Professor of Civil Engineering, University at Buffalo, State University of New York

Emmanuel Maragakis, Professor and Chair, Department of Civil Engineering, University of Nevada, Reno

Sheng-Taur Mau, Distinguished Professor of Civil Engineering, New Jersey Institute of Technology

Ronald L. Mayes, President, Dynamic Isolation Systems, Inc.

Ronald Meis, Graduate Researcher, University of Nevada, Reno

Thomas D. O'Rourke, Thomas R. Briggs Professor of Civil Engineering, Cornell University

Maurice S. Power, Vice President, Geomatrix Consultants, Inc.

Andrei M. Reinhorn, Professor of Civil Engineering, University at Buffalo, State University of New York

Adam Rose, Professor and Head, Department of Energy, Environmental and Mineral Economics, The Pennsylvania State University

Masanobu Shinozuka, Fred Champion Chair in Civil Engineering, University of Southern California

Raj Siddharthan, Professor of Civil Engineering, University of Nevada, Reno

Kathleen J. Tierney, Co-Director, Disaster Research Center, University of Delaware

Mai Tong, Research Scientist, Multidisciplinary Center for Earthquake Engineering Research

Selcuk Toprak, Research Civil Engineer, U.S. Geological Survey

David M. Tralli, MCEER Consultant

T. Leslie Youd, Professor and Chair of Civil and Environmental Engineering, Brigham Young University

▲ **Production Staff**

Jane E. Stoyale, Editor

Jenna L. Tyson, Layout and Design

Hector A. Velasco, Illustration



MULTIDISCIPLINARY CENTER FOR EARTHQUAKE ENGINEERING RESEARCH

A National Center of Excellence in Advanced Technology Applications

University at Buffalo, State University of New York
Red Jacket Quadrangle ■ Buffalo, New York 14261-0025
Phone: 716/645-3391 ■ Fax: 716/645-3399
E-mail: mceer@acsu.buffalo.edu ■ WWW Site: <http://mceer.buffalo.edu>